

Aruba 3B
Art. Nr. 4014610
1/€



15.05.2019

Art. Nr. 4014610

Groundplan - Grundplan - Plan de masse - Planimetria -
Plattegrond - Põhiplaan

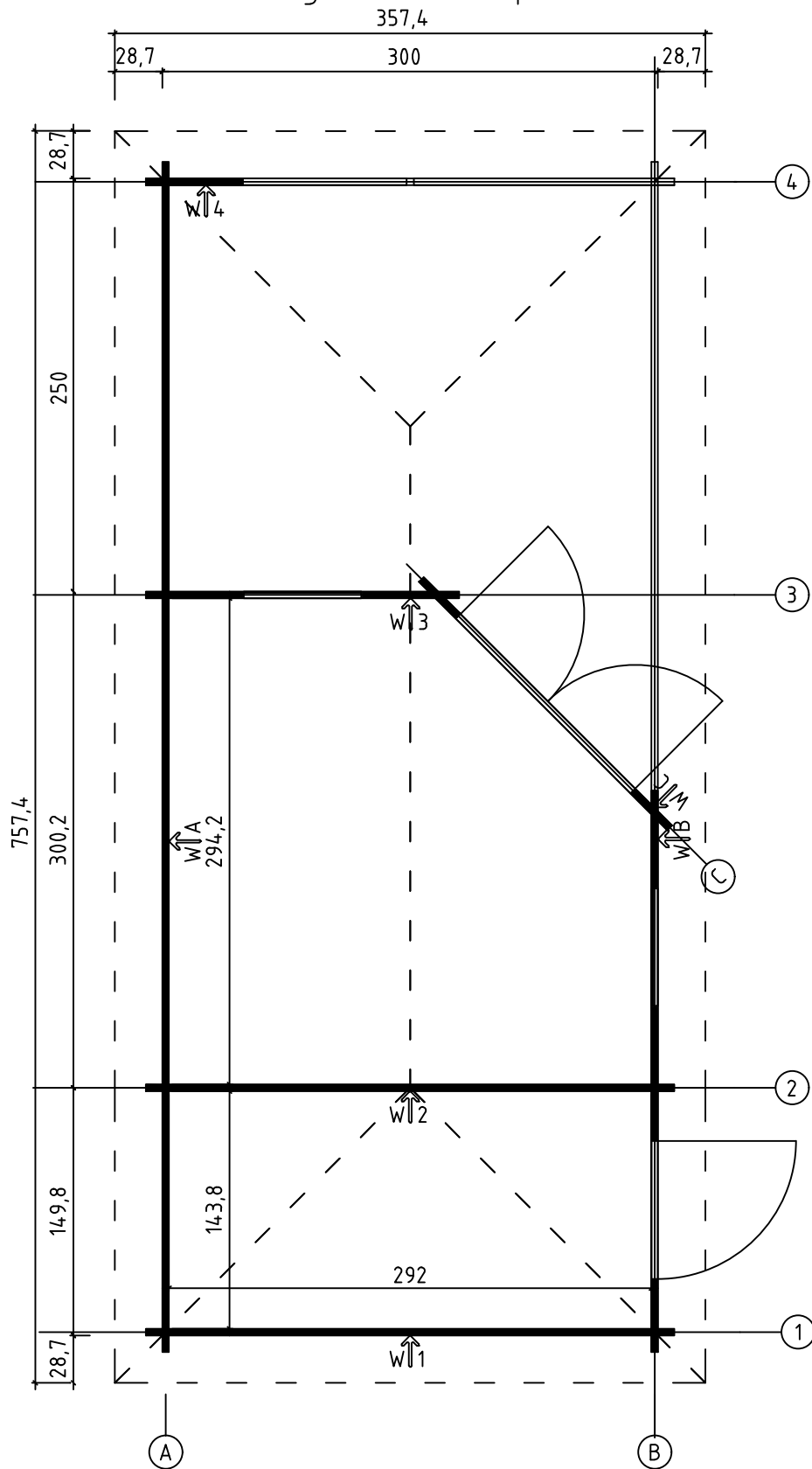

Art. Nr. 4014610

Terrace boards - Terrassenbretter - Plancher de terrasse -
Piattaforme terrazzo - Terrasvloer - Terrassilaudis

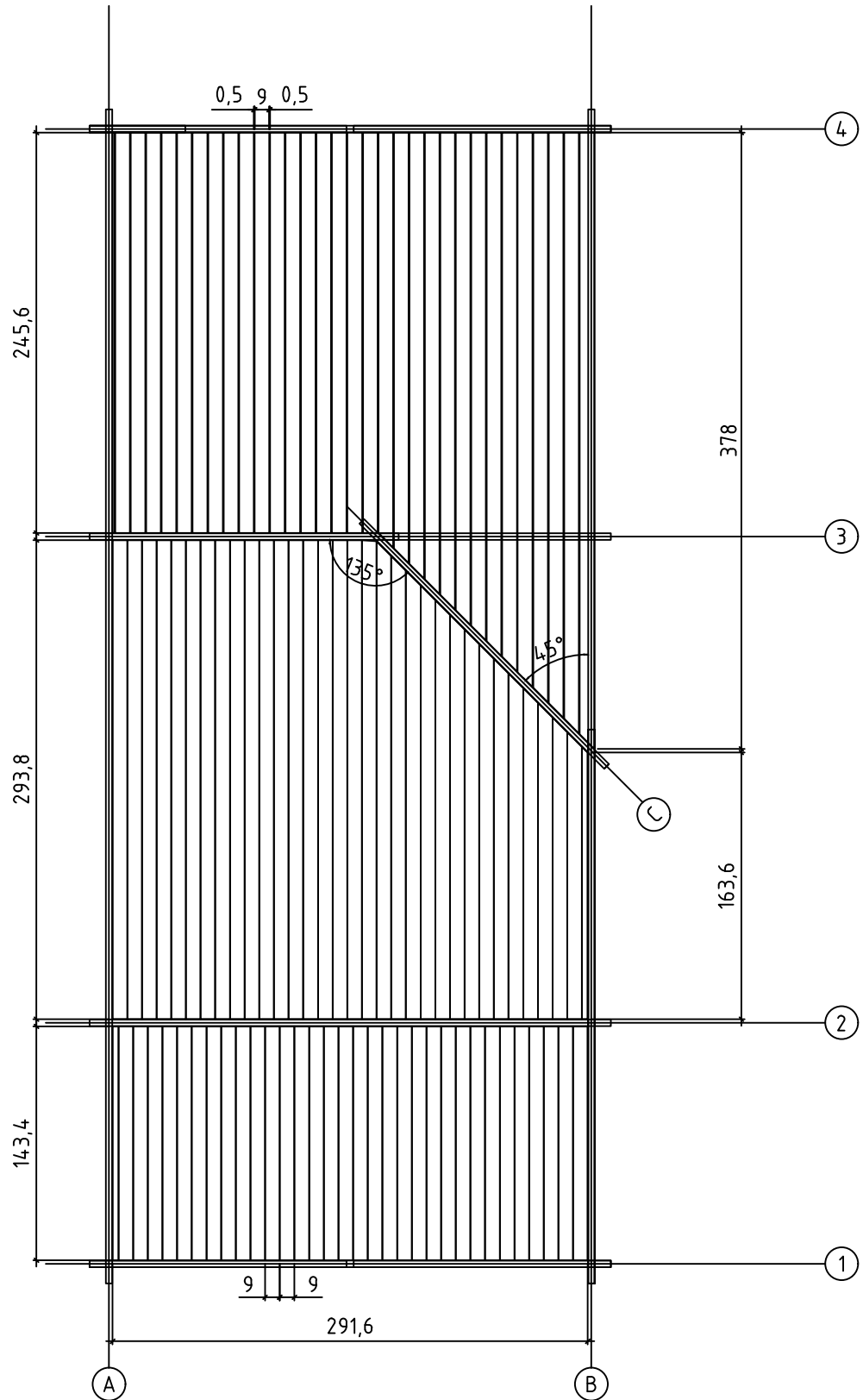

Floor boards - Fussbodenbretter - Plan pose plancher -
Pavimento - Vloerhout - Põrandalaudis

Overhead beams - Deckenbalken - Solives - Travi a vista -
Overlopende balken - Laetalade konstruksioon

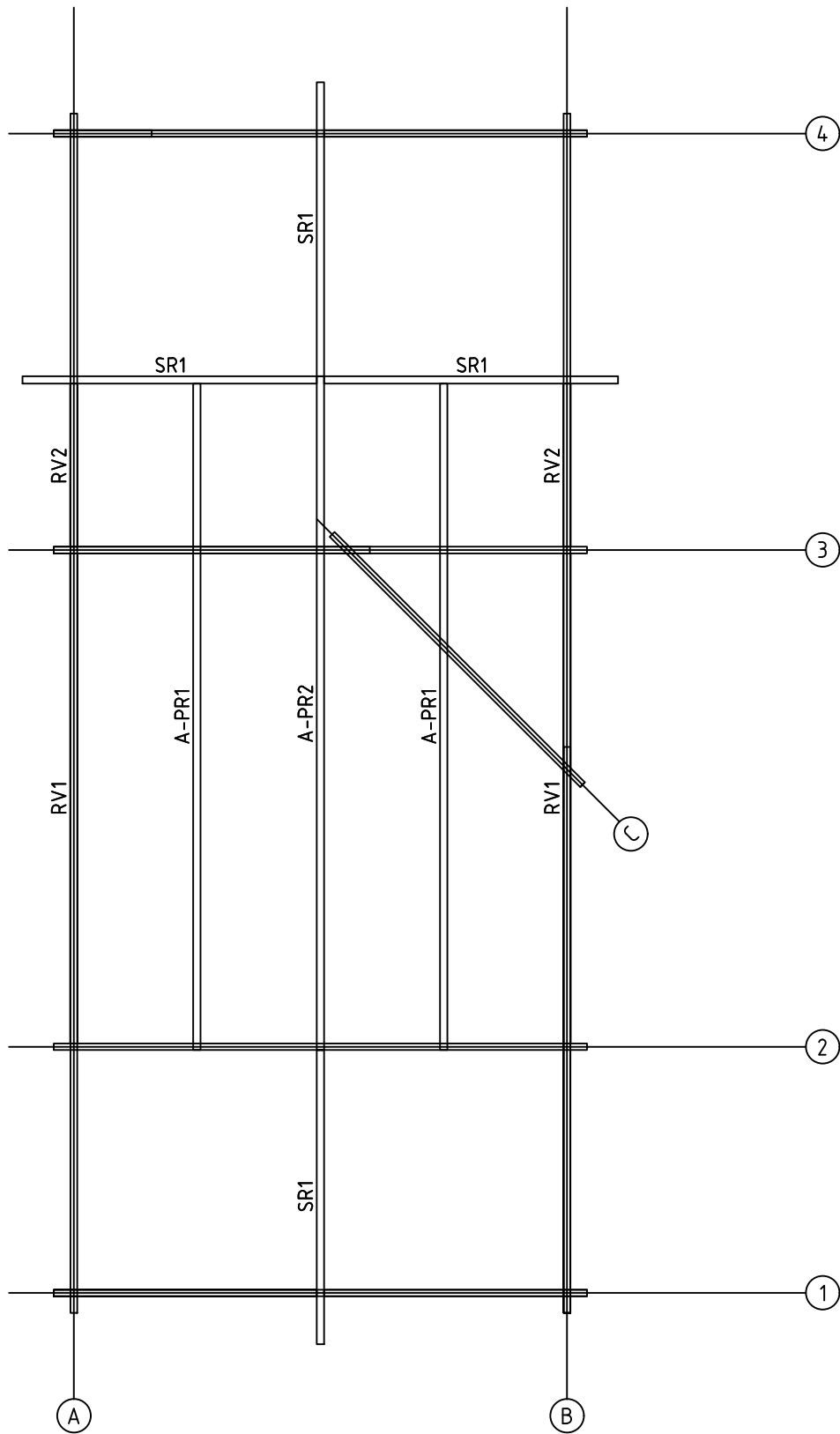

Art. Nr. 4014610

Diagonals must be equal - Prüfung diagonale Austrichtung -
Controle des diagonales - Le diagonali devono essere eguali -
Gelijkbenige diagonaal - Diagonaalid peavad olema võrdsed

$$A=B, C=D; E=F$$

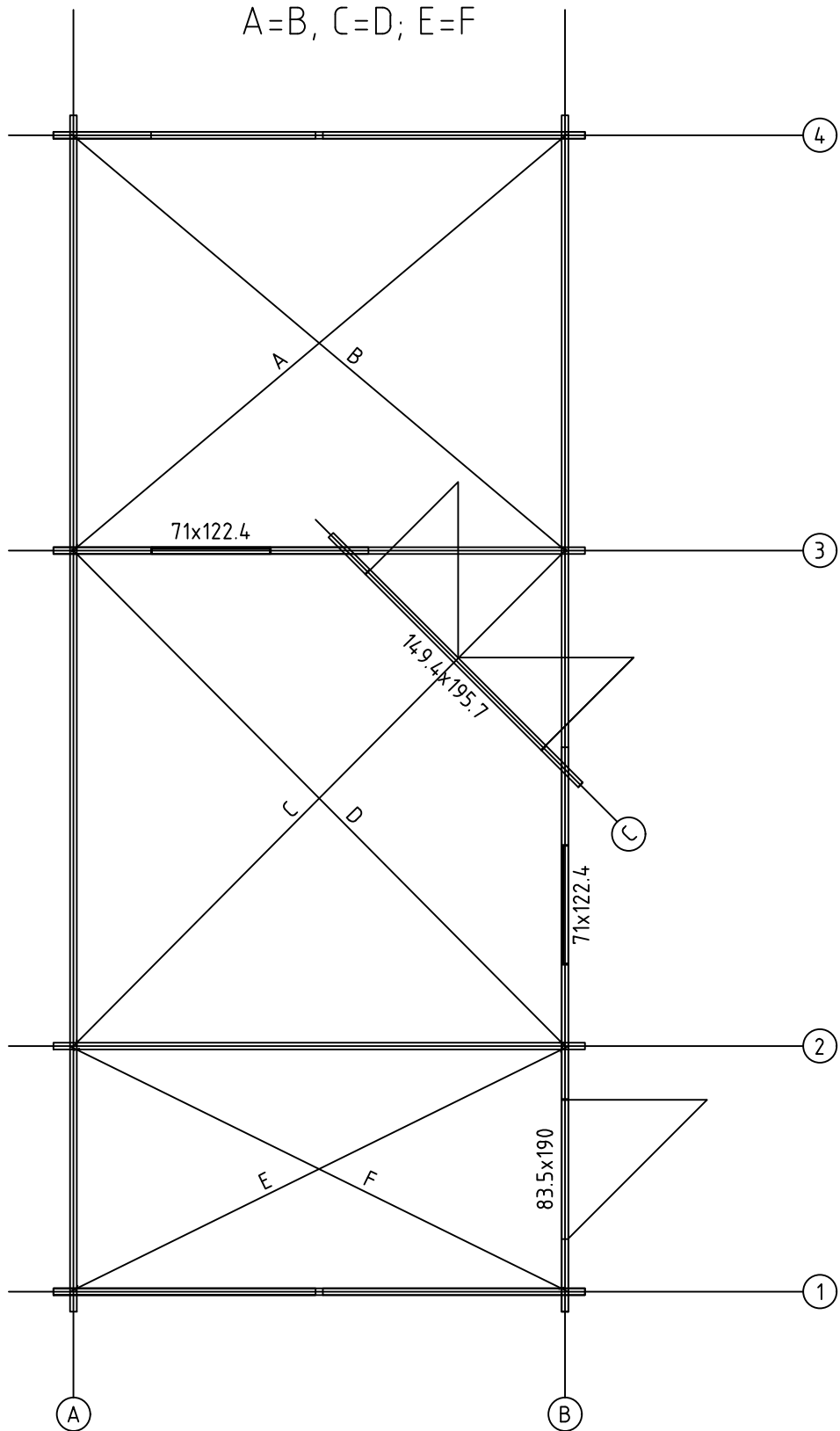

Art. Nr. 4014610

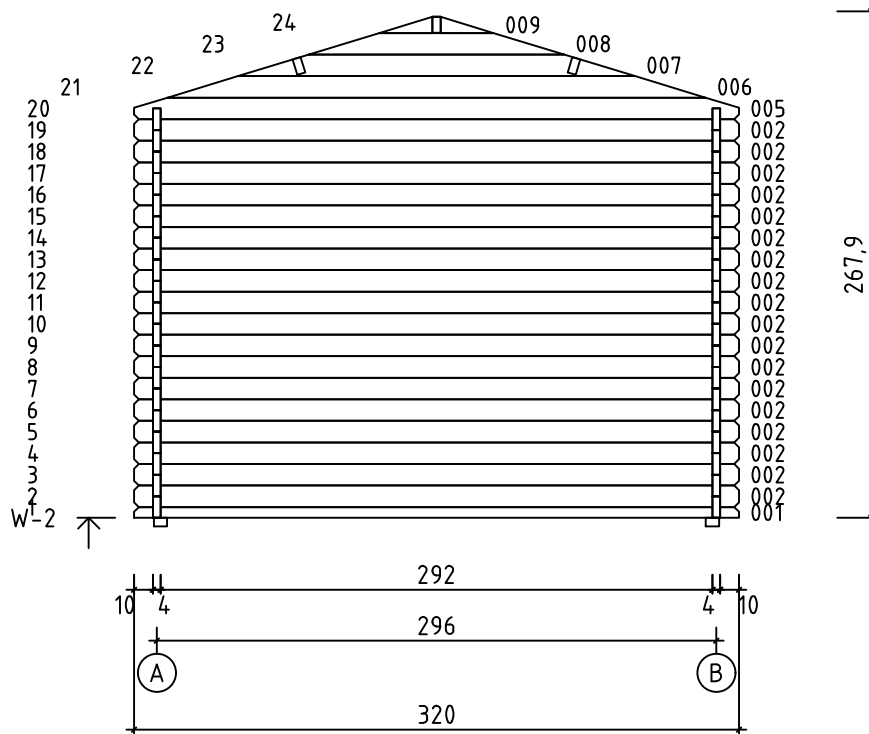
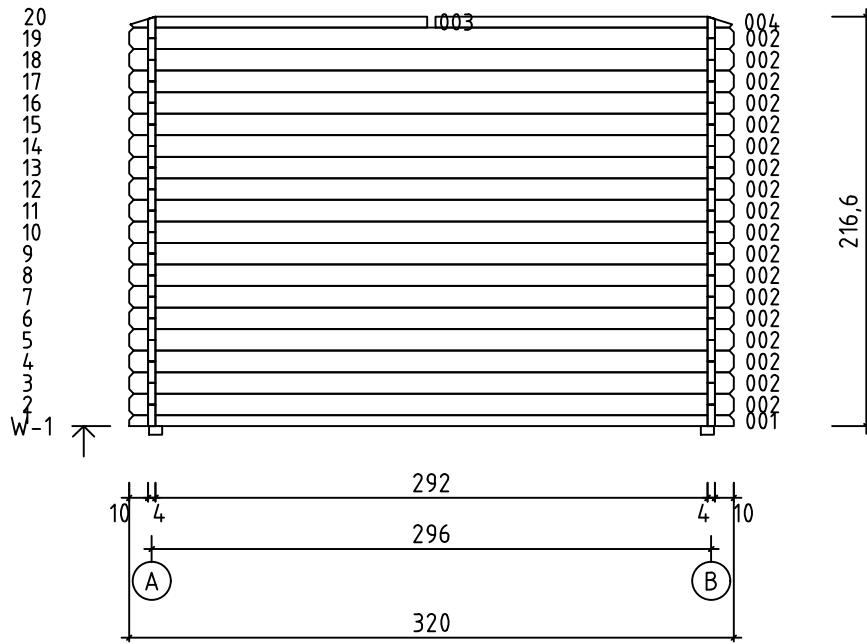

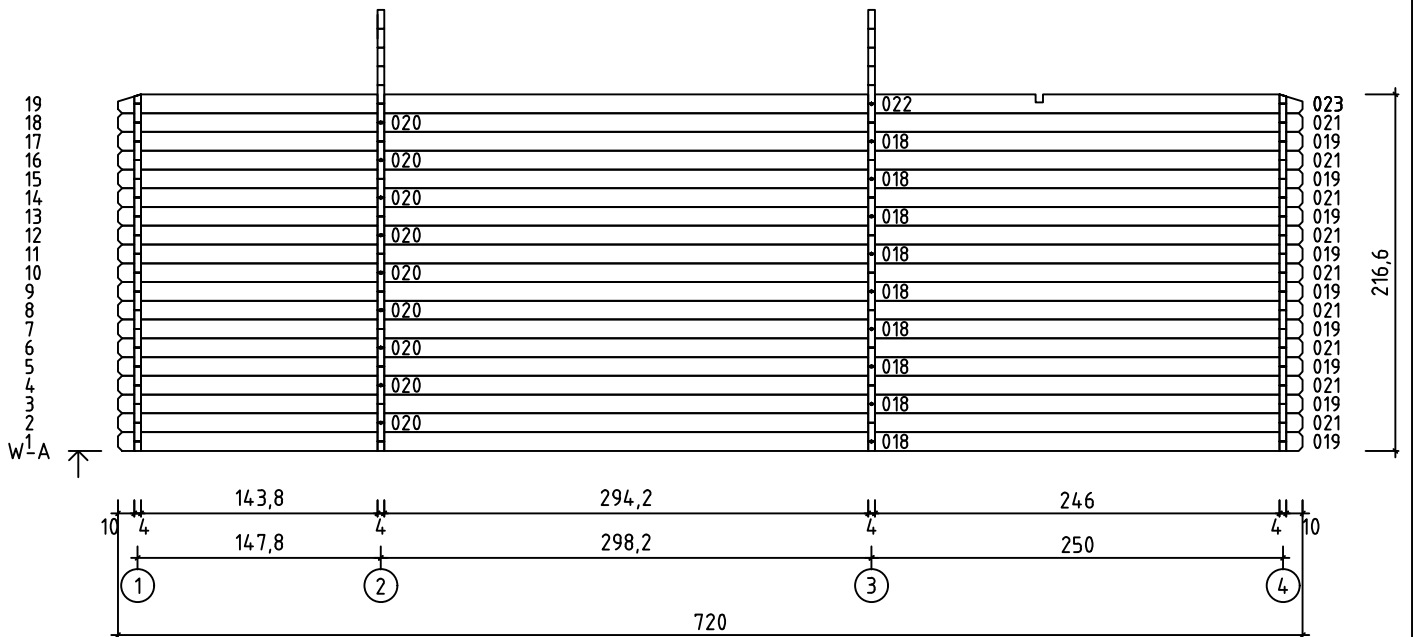
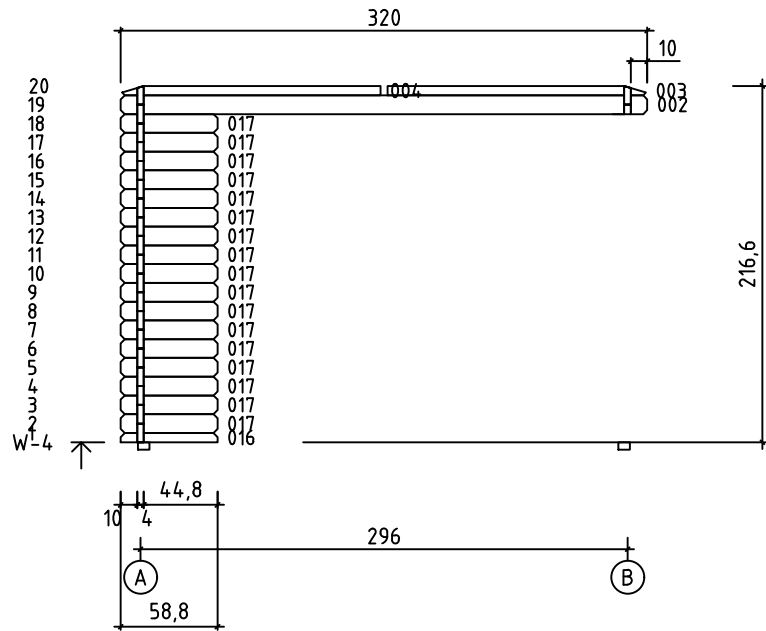

Art. Nr. 4014610

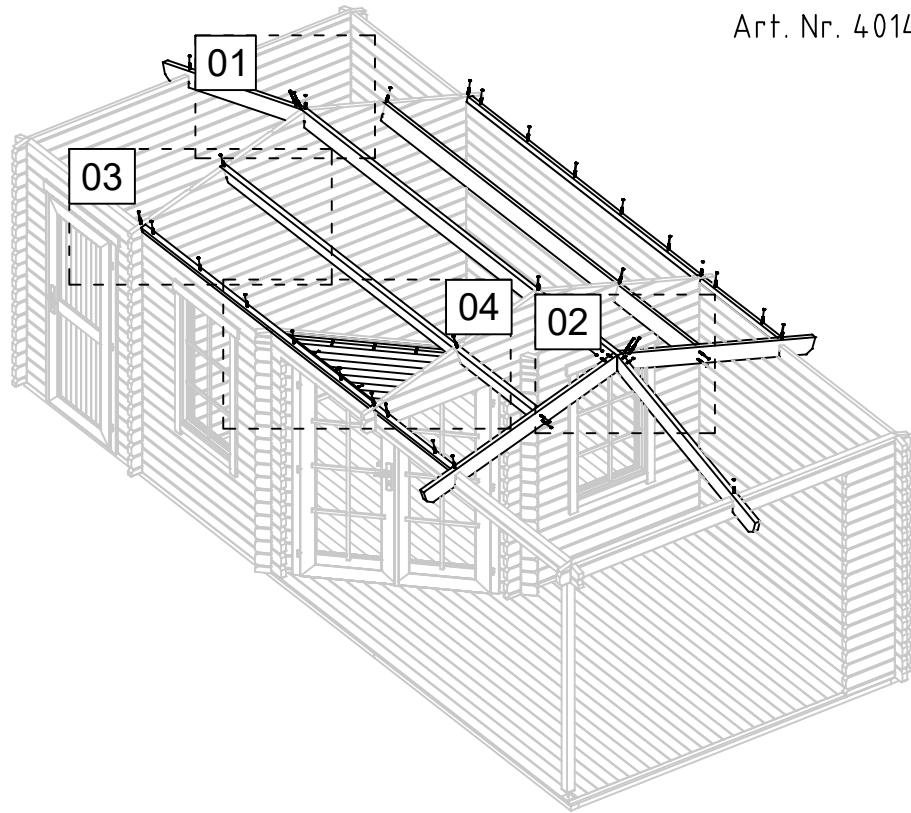

01

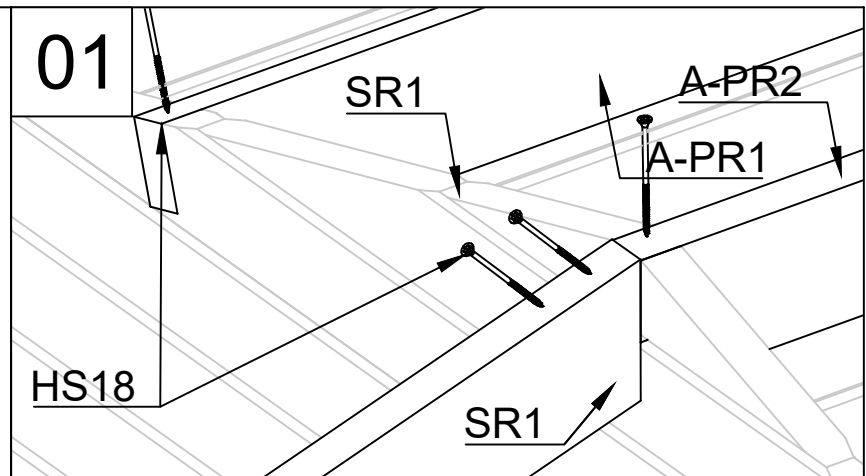

02

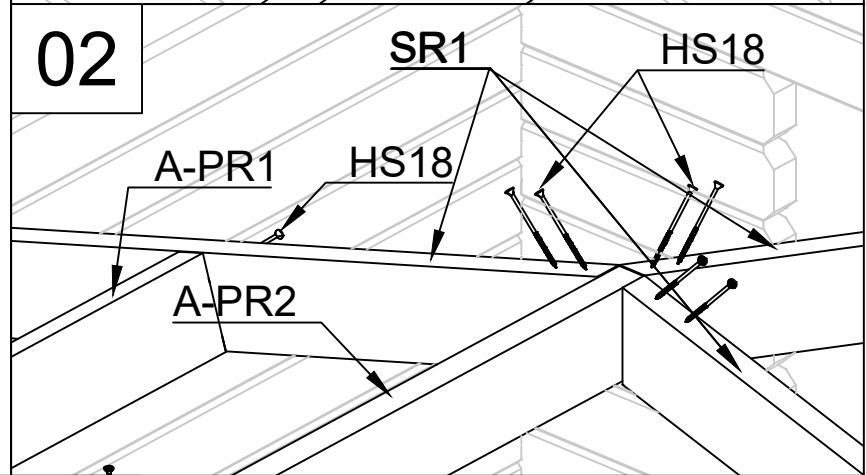

04

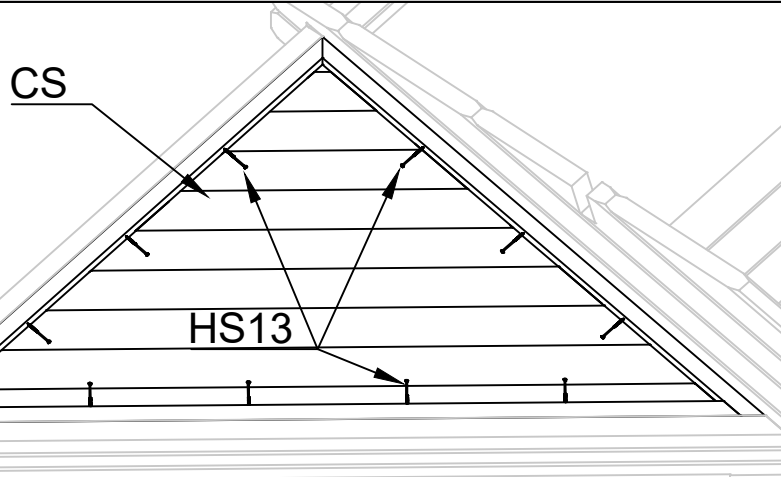

03

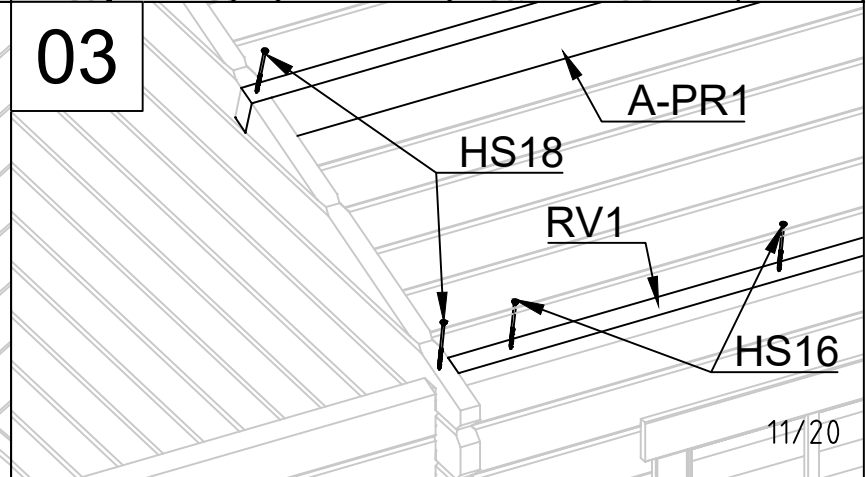

15.05.2019

11/20

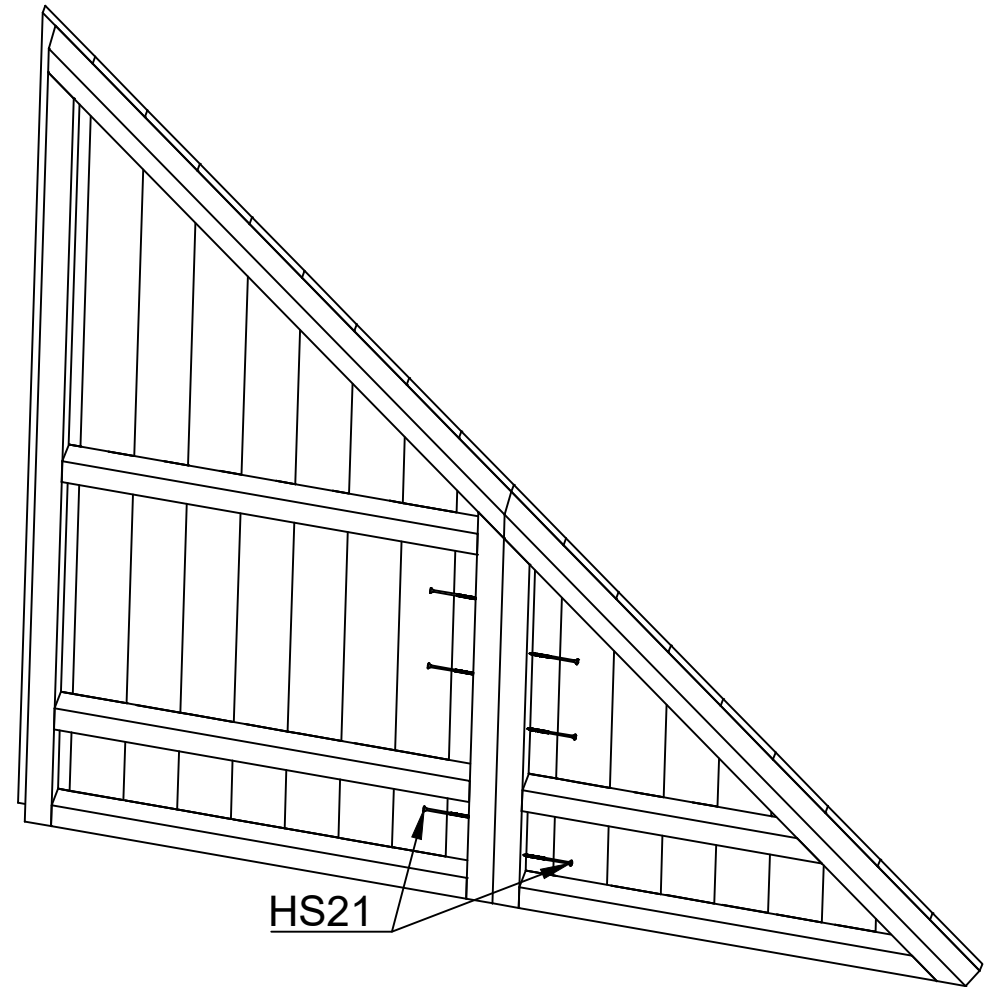
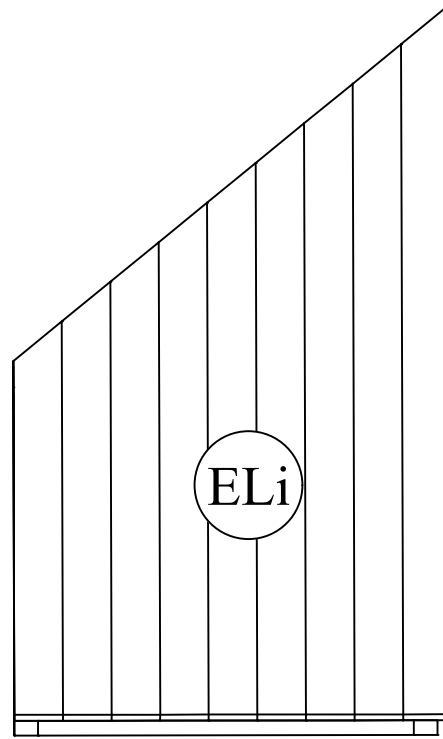
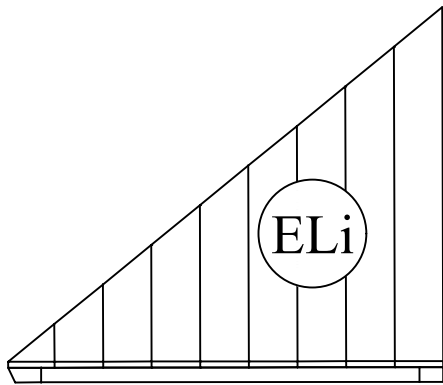

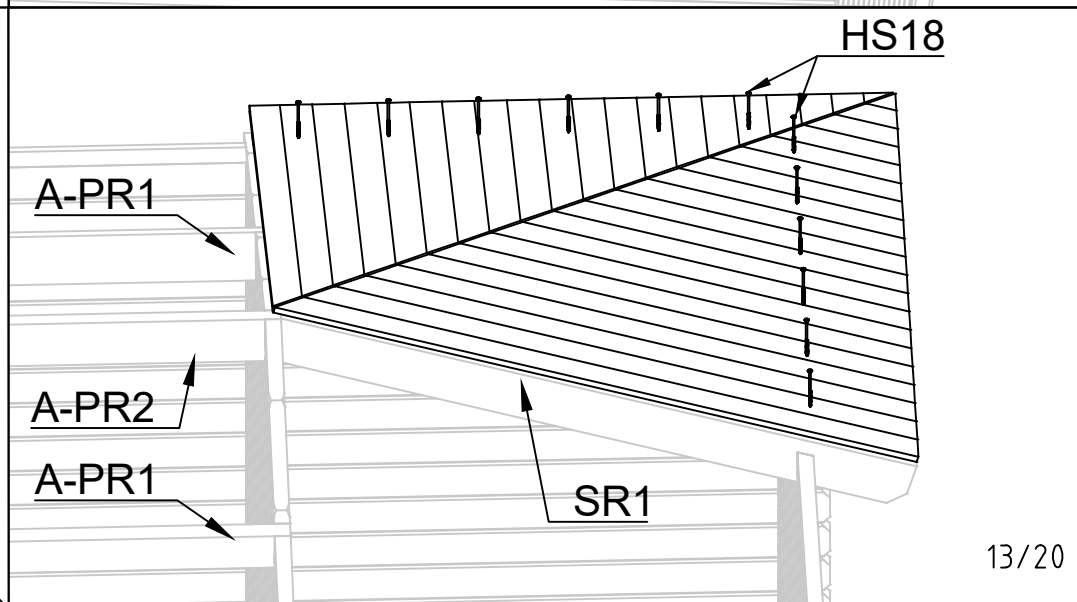
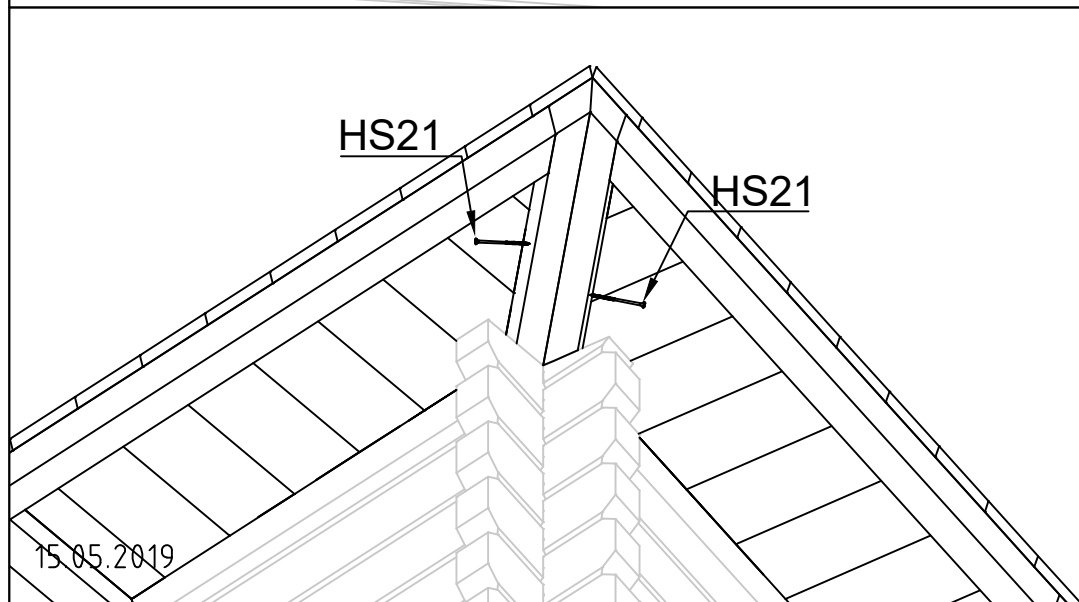
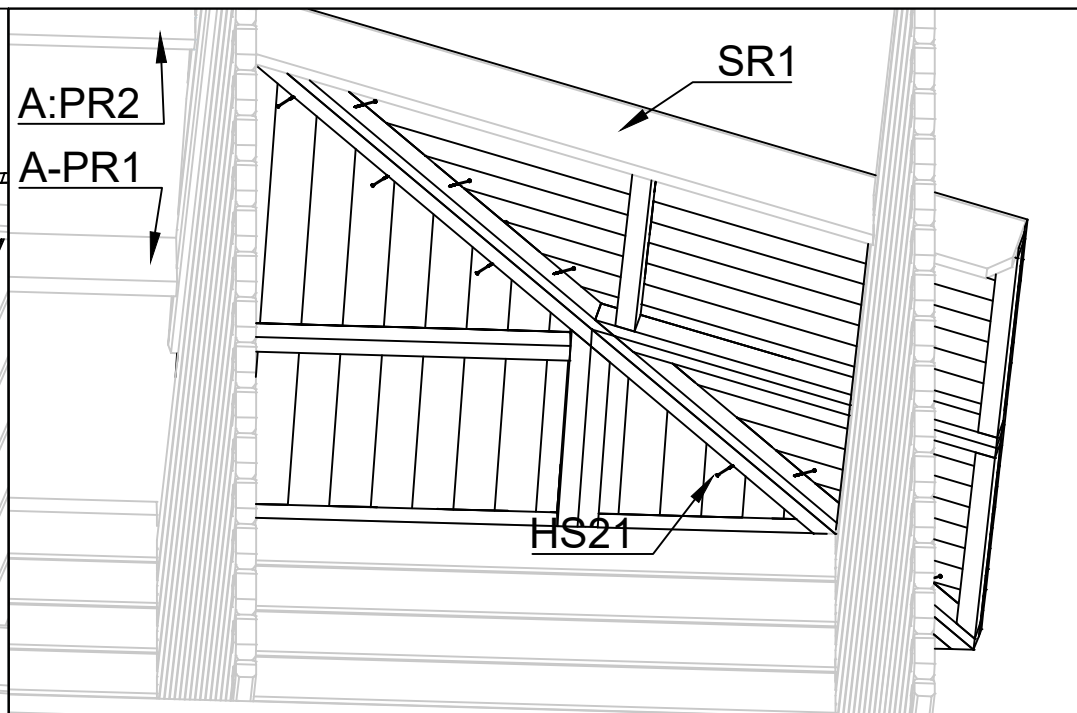
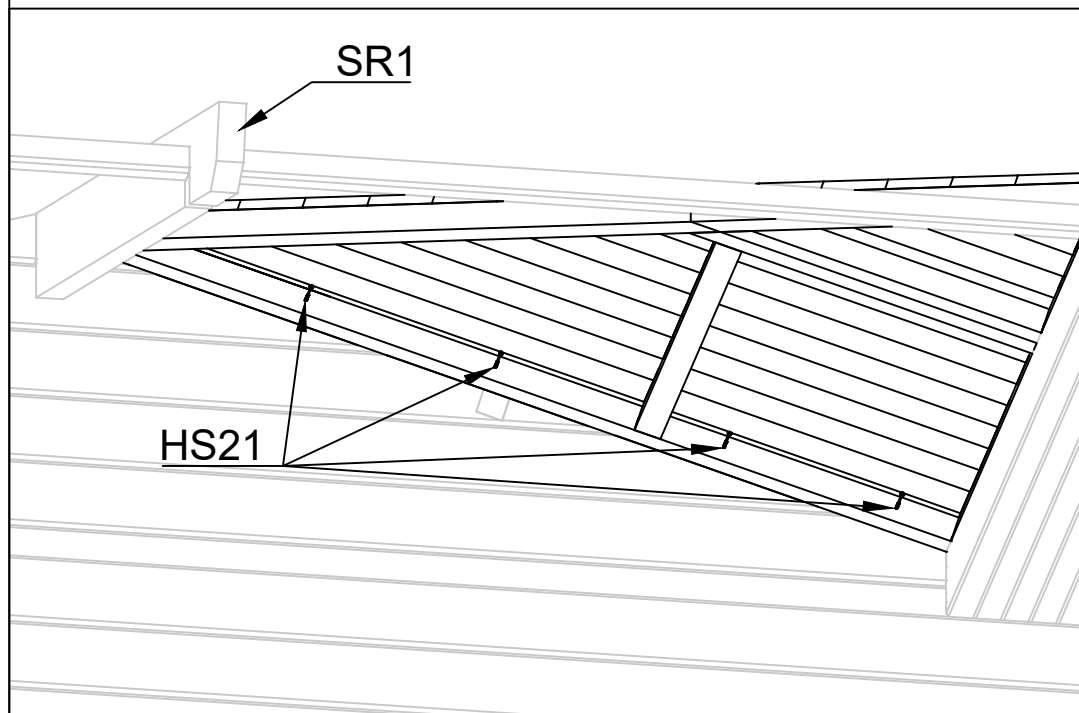

1

Art.Nr. 4014610

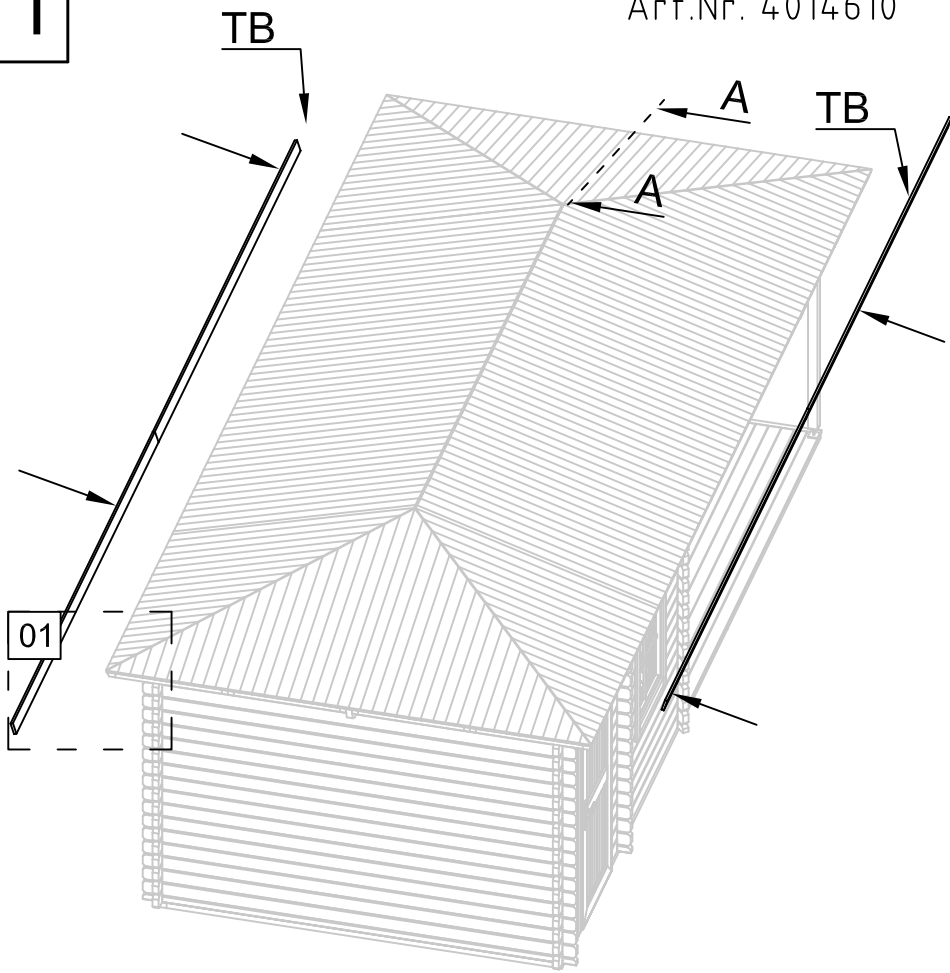

A-A

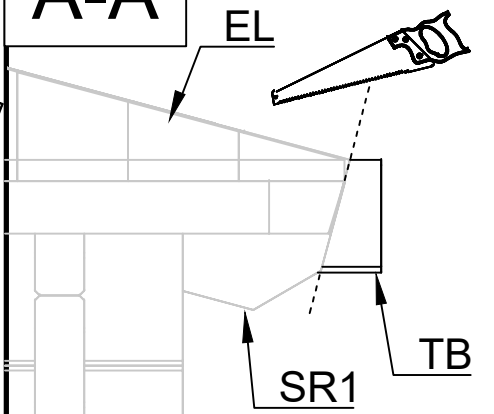

01

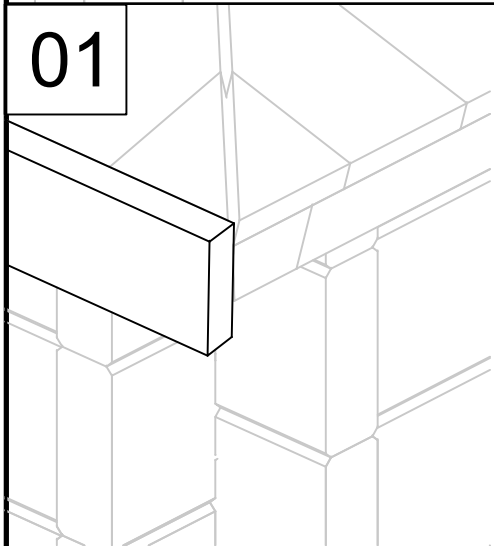

2

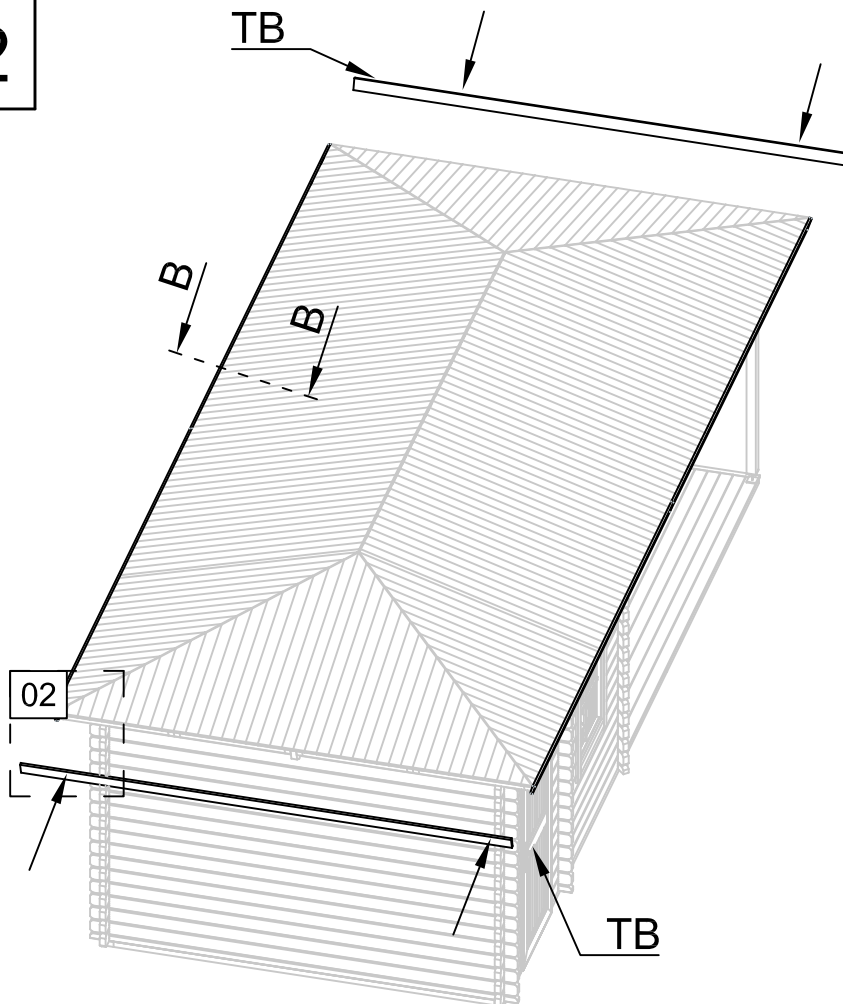



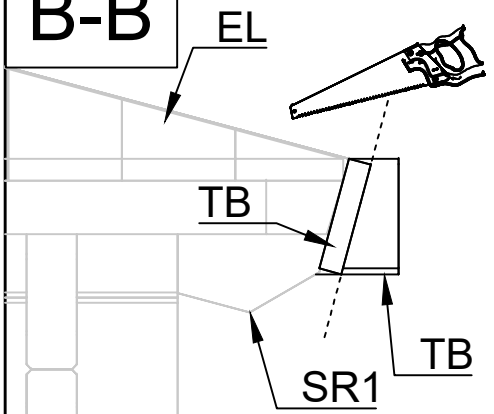



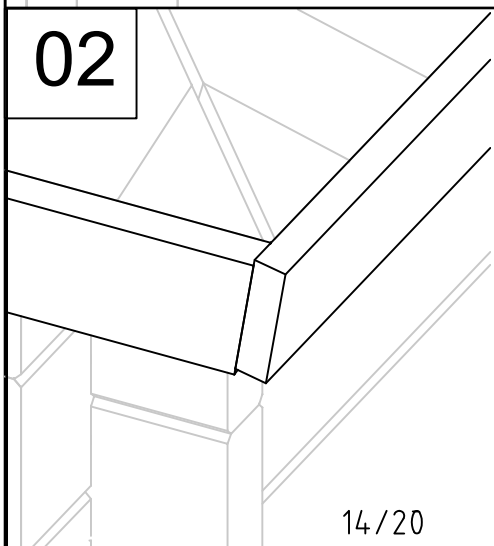

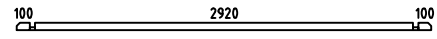
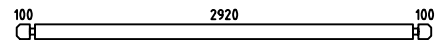
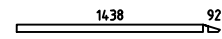
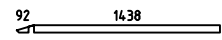
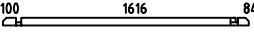
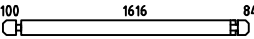

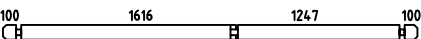

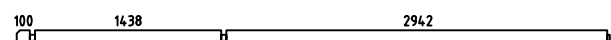
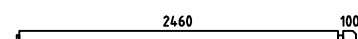
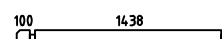
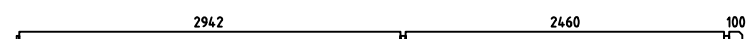
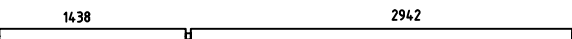
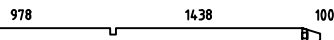

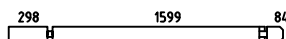
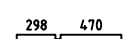

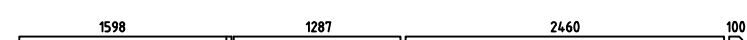
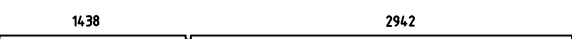

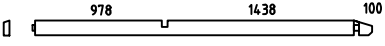

B-B

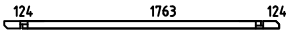
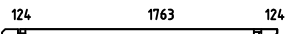
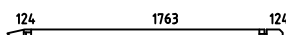
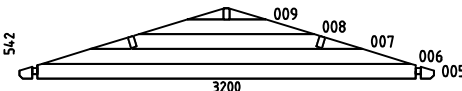
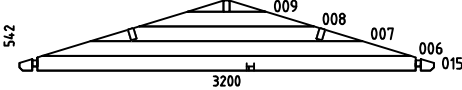
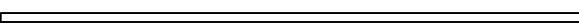

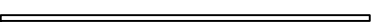
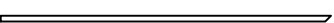
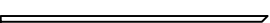



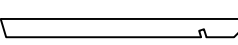



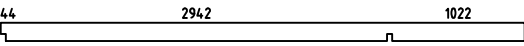
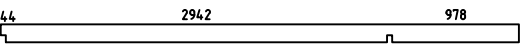

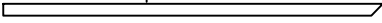
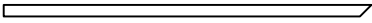

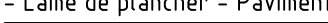

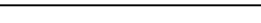
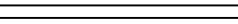
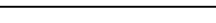
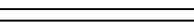
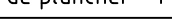







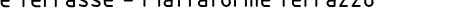

02

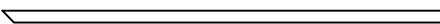

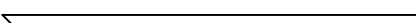
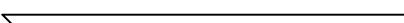
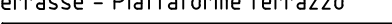
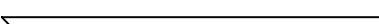
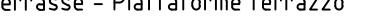
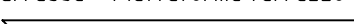

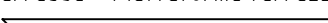
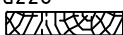

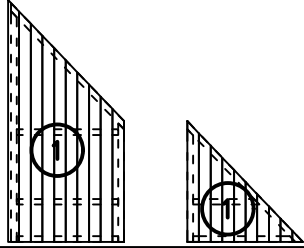
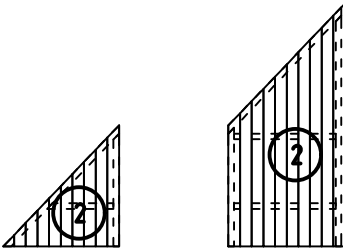
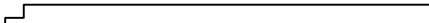

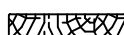

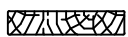













Pos	15.05.2019	Piece list - Stückliste - Liste des pièces - Elementi - Stuklijst - Tükítabel Art. Nr. 4014610	15/20	Q	P (mm)	L (mm)
001				2	40x57	3200
002				37	40x114	3200
003				2	40x57	1570
004				2	40x57	1570
010				1	40x57	1897
011				6	40x114	1897
012				11	40x114	588
013				11	40x114	588
014				1	40x114	3200
016				1	40x57	588
017				17	40x114	588
018				9	40x114	4580
019				9	40x114	2620
020				10	40x114	1598
021				9	40x114	5602
022				1	40x114	4580
023				1	40x114	2620
024				17	40x114	436
025				6	40x114	2118
026				11	40x114	808
027				11	40x114	588
028				1	40x114	5602
029				1	40x114	4580



Pos	15.05.2019	Piece list - Stückliste - Liste des pièces - Elementi - Stuklijst - Tükitalabel Art. Nr. 4014610	16/20	Q	P (mm)	L (mm)
030				1	40x114	2620
031				1	40x57	310
032				17	40x114	310
033				17	40x114	310
034				1	40x57	310
035				1	40x57	2125
036				1	40x57	2125
037				1	40x57	2125
W2-1				1		
W3-1				1		
IAR1				2	70x45	4475
IAR5				2	70x45	2850
IAR2				2	70x45	2515
IAR6				13	45x45	2850
IAR9				1	45x45	2550
IAR7				1	45x45	2060
IAR3				1	45x45	1810
IAR4				1	45x45	1720
IAR8				1	45x45	707
IAR10				1	45x45	218
SR1				4	44x140	1845
RV1				2	44x44	2942
RV2				2	44x44	978

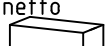

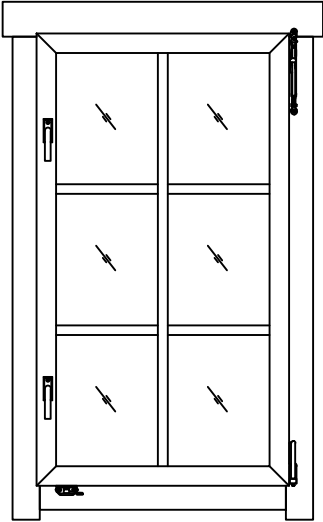
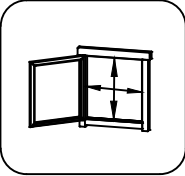
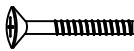
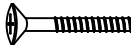

Pos	15.05.2019	Piece list - Stückliste - Liste des pièces - Elementi - Stuklijst - Tükítabel Art. Nr. 4014610	17/20	Q	P (mm)	L (mm)
A-PR2		Roof beam - Dachbalken - Panne de toit - Perlina del tetto - Gordingen / dakbalk - Pärlin 44  2942 1022		1	44x140	4044
A-PR1		Roof beam - Dachbalken - Panne de toit - Perlina del tetto - Gordingen / dakbalk - Pärlin 44  2942 978		2	44x140	4000
		Floor boards - Fussbodenbretter - Lamé de plancher - Pavimento - Vloerhout - Pörandalaud 		18	90x18	2938
		Floor boards - Fussbodenbretter - Lamé de plancher - Pavimento - Vloerhout - Pörandalaud 		1	90x18	2931
		Floor boards - Fussbodenbretter - Lamé de plancher - Pavimento - Vloerhout - Pörandalaud 		1	90x18	2841
		Floor boards - Fussbodenbretter - Lamé de plancher - Pavimento - Vloerhout - Pörandalaud 		1	90x18	2751
		Floor boards - Fussbodenbretter - Lamé de plancher - Pavimento - Vloerhout - Pörandalaud 		1	90x18	2661
		Floor boards - Fussbodenbretter - Lamé de plancher - Pavimento - Vloerhout - Pörandalaud 		1	90x18	2571
		Floor boards - Fussbodenbretter - Lamé de plancher - Pavimento - Vloerhout - Pörandalaud 		1	90x18	2481
		Floor boards - Fussbodenbretter - Lamé de plancher - Pavimento - Vloerhout - Pörandalaud 		1	90x18	2391
		Floor boards - Fussbodenbretter - Lamé de plancher - Pavimento - Vloerhout - Pörandalaud 		1	90x18	2301
		Floor boards - Fussbodenbretter - Lamé de plancher - Pavimento - Vloerhout - Pörandalaud 		1	90x18	2211
		Floor boards - Fussbodenbretter - Lamé de plancher - Pavimento - Vloerhout - Pörandalaud 		1	90x18	2121
		Floor boards - Fussbodenbretter - Lamé de plancher - Pavimento - Vloerhout - Pörandalaud 		1	90x18	2031
		Floor boards - Fussbodenbretter - Lamé de plancher - Pavimento - Vloerhout - Pörandalaud 		1	90x18	1941
		Floor boards - Fussbodenbretter - Lamé de plancher - Pavimento - Vloerhout - Pörandalaud 		1	90x18	1851
		Floor boards - Fussbodenbretter - Lamé de plancher - Pavimento - Vloerhout - Pörandalaud 		1	90x18	1761
		Floor boards - Fussbodenbretter - Lamé de plancher - Pavimento - Vloerhout - Pörandalaud 		1	90x18	1671
		Floor boards - Fussbodenbretter - Lamé de plancher - Pavimento - Vloerhout - Pörandalaud 		33	90x18	1434
		Terrace boards - Terrassenbretter - Plancher de terrasse - Piattaforme terrazzo Terrasvloer - Terrassilaud 		1	90x19	3780
		Terrace boards - Terrassenbretter - Plancher de terrasse - Piattaforme terrazzo Terrasvloer - Terrassilaud 		1	90x19	3685
		Terrace boards - Terrassenbretter - Plancher de terrasse - Piattaforme terrazzo Terrasvloer - Terrassilaud 		1	90x19	3590
		Terrace boards - Terrassenbretter - Plancher de terrasse - Piattaforme terrazzo Terrasvloer - Terrassilaud 		1	90x19	3495

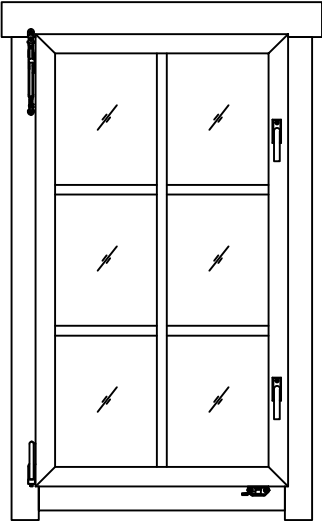
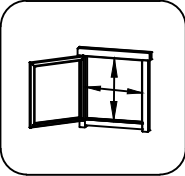

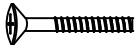
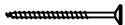

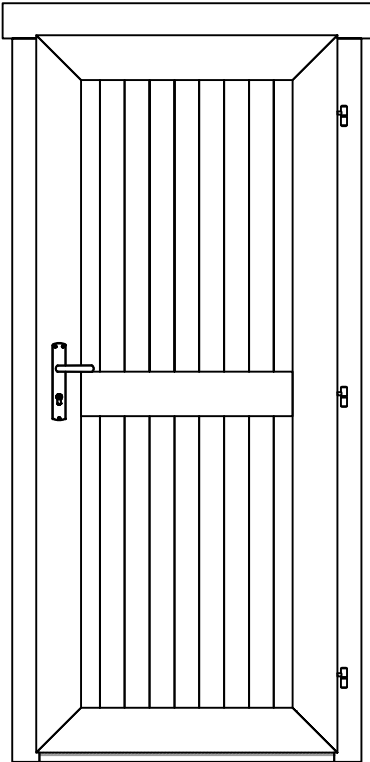
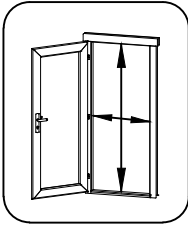

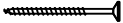
Pos	15.05.2019	Piece list - Stückliste - Liste des pièces - Elementi - Stuklijst - Tükitalabel Art. Nr. 4014610	18/20	Q	P (mm)	L (mm)
		Terrace boards - Terrassenbretter - Plancher de terrasse - Piattaforme terrazzo Terrasvloer - Terrassilaud 		1	90x19	3400
		Terrace boards - Terrassenbretter - Plancher de terrasse - Piattaforme terrazzo Terrasvloer - Terrassilaud 		1	90x19	3305
		Terrace boards - Terrassenbretter - Plancher de terrasse - Piattaforme terrazzo Terrasvloer - Terrassilaud 		1	90x19	3210
		Terrace boards - Terrassenbretter - Plancher de terrasse - Piattaforme terrazzo Terrasvloer - Terrassilaud 		1	90x19	3115
		Terrace boards - Terrassenbretter - Plancher de terrasse - Piattaforme terrazzo Terrasvloer - Terrassilaud 		1	90x19	3020
		Terrace boards - Terrassenbretter - Plancher de terrasse - Piattaforme terrazzo Terrasvloer - Terrassilaud 		1	90x19	2925
		Terrace boards - Terrassenbretter - Plancher de terrasse - Piattaforme terrazzo Terrasvloer - Terrassilaud 		1	90x19	2830
		Terrace boards - Terrassenbretter - Plancher de terrasse - Piattaforme terrazzo Terrasvloer - Terrassilaud 		1	90x19	2735
		Terrace boards - Terrassenbretter - Plancher de terrasse - Piattaforme terrazzo Terrasvloer - Terrassilaud 		1	90x19	2640
		Terrace boards - Terrassenbretter - Plancher de terrasse - Piattaforme terrazzo Terrasvloer - Terrassilaud 		1	90x19	2545
		Terrace boards - Terrassenbretter - Plancher de terrasse - Piattaforme terrazzo Terrasvloer - Terrassilaud 		18	90x19	2456
		Roof boards - Dachbretter - Voliges - Perlina per tetto - Dakhout - Katuselaud 		90	90x18	1868
CS		Ceiling shield - Element - Panneau de toiture - Pannelo del soffitto - Plafond bedeking - Laekilp 		1		
EL		Roof element - Dachelement - Panneau de toit prémonté - Componente del tetto - Dakelement - Katusekilp 		4		
EL		Roof element - Dachelement - Panneau de toit prémonté - Componente del tetto - Dakelement - Katusekilp 		4		
		Post - Pfosten - Poteau - Piede registrabile - Stijl - Post 		1	70x70	1883
		Floor fillet - Fussbodenleiste - Corniere de finition du plancher - Finitura per pavimento (battisco pa) - Vloerafwerklijst - Pörandaliist 			18x18	19.65
TB-1		Fascia board - Traufbrett - Bandeau de toit - Finitura lati tetto - Gevellijst - Räästalaud 		2	18x90	3674

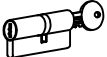
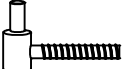
Pos	15.05.2019	Piece list - Stückliste - Liste des pièces - Elementi - Stuklijst - Tükítabel Art. Nr. 4014610	19/20	Q	P (mm)	L (mm)
TB-2	Fascia board - Traufbrett - Bandeau de toit - Finitura lati tetto - Gevellijst - Räästalaud 			4	18x90	3840
DRV-1	Roof edge reinforcement - Dachrandverstärkung - Corniere de renfort de bord de toit - Rinforzo x tetto - Dakrand versterking - Räästatugevdus 			2	44x44	4000
	Terrace edge board - Terrassenbrett, eingang - Lamé de seuil d'entree de terrasse - Terrazzo uso abitacolo - Terrasvloer dorpel - Terrassi servaliist 			1	19x40	2510
KFS-1	Storm protection - Sturmleiste - Latte anti-tempete - Protezione anti vento - Stormverankering / beveiliging - Tormikinnitusliist 			6	22x45	2500
HS12	Screw for fascia boards - Schrauben für traufbretter - Vis pour fixation bandeau de toit - Viti x striscia del tetto - Schroef voor gevellijst - Kruvi räästalauale 			52	4x40	
HS12	Screws for terrace edge board - Schrauben für terrassenbrett - Vis de fixation de lame de seuil d'entree de terrasse - Vite per unire delle assi del terrazzo - Schroeven voor terrashout - Kruvi terrassi servaliistule 			7	4x40	
HS13	Screw for triangular fixing - Montagschraube für dreieckige - Vis d'assemblage pour triangle - Vite per fissaggio triangolare - Schroef voor driehoekig afdeklijst - Kruvi kolmnurga monteerimiseks seinale 			10	4x60	
HS13	Screw for post - Schrauben für pfosten - Vis de fixation des poteaux - Viti per inviare - Schroef voor stijlen - Kruvi postile 			2	4x60	
HS13	Screw for roof edge reinforcement - Schrauben für dachrandverstärkung - Vis pour fixation corniere renfort de bord de toit - Viti x rinforzo bordo tetto - Schroef voor dakrand versterking - Kruvi räästatugevdusele 			18	4x60	
HS18	Screw for foundation - Schrauben zur befestigung fundament - Vis de fixations des poutrelles de fondations - Viti x fondamenta - Schroef voor fundering - Kruvi alusraamile 			42	5x120	
HS18	Screw for fixing roof elements - Schraube für befestigung dachelementen - Vis de fixation des panneaux de toit - Vite per fissare gli elementi del tetto - Schroef voor bevestiging dakelement - Kruvi kilpide kinnitamiseks seinaga 			48	5x120	
HS18	Screw for roof beams - Schrauben für dachbalken - Vis pour fixation pannes de toit - Viti per perline del tetto - Schroef voor gordingen / dakbalken - Kruvi pärlinitele 			22	5x120	
HS18	Screw for wall details - Schraube für wand details - Vis pour mur details - Viti per elementi della porta - Schroef voor wand details - Kruvi seinadetailidele 			25	5x120	
HS18	Screw for gable - Schrauben für giebel - Vis pour fixation des pignons - Viti per timpano - Schroef voor gevelpunt - Kruvi viilude kinnitamiseks 			4	5x120	
HS16	Screw for 1. wall beam - Schraube für 1. bohlenreihe - Vis de fixations 1ere rangée de madriers avec poutrelles de fondations - Vite fissaggio alle fondamenta - Schroef voor 1 wandbalk - Kruvi poollauale 			10	5x90	
HS16	Screw for foundation - Schrauben zur befestigung fundament - Vis de fixations des poutrelles de fondations - Viti x fondamenta - Schroef voor fundering - Kruvi alusraamile 			6	5x90	
HS20	Screw for post height adjustment - Schrauben für regulierungsschraube für pfosten - Vis de fixation de support réglable de poteau - Viti per fissare ed aggiustare l'altezza del palo verticale - Schroef voor hoogte instelling stijlen - Kruvi vajumispoldile 			8	6x50	
HS21	Screw for fixing roof elements - Schraube für befestigung dachelementen - Vis de fixation des panneaux de toit - Vite per fissare gli elementi del tetto - Schroef voor bevestiging dakelement - Kruvi kilpide montaažiks 			120	6x80	
HS24	Screw for wall details - Schraube für wand details - Vis pour mur details - Viti per elementi della porta - Schroef voor wand details - Kruvi seinadetailidele 			8	8x220	
NF2	Zn nail for floor fillet - Zn nagel für fussbodenleiste - Pointe pour corniere de finition du plancher - Chiodi x fissaggio pavimento - Spijker(nagel) voor vloer afdeklijst - Nael põrandaliistule 			40	1.4x40	
SH40	Hammer block - Schlagholz - Calé de frappe - Blocco di legno da usare come cuscinetto quando si usa il martello - Slagklos - Löögiklots 			1		
SFS	Nut for storm protection - Schraubenmutter für sturmleiste - Ecrou pour latte anti-tempete - Dado x asta protezione vento - Moer voor stormverankering - Mutter tormikinnitusliistule 			12	D6	
NF3	Zn nail for terrace - Zn nagel für terrassenbretter - Pointe pour plancher de terrasse - Chiodo zincato per terrazza - Spijker(nagel) voor terrasvloer - Nael terrassilauale 			402	2.1x50	

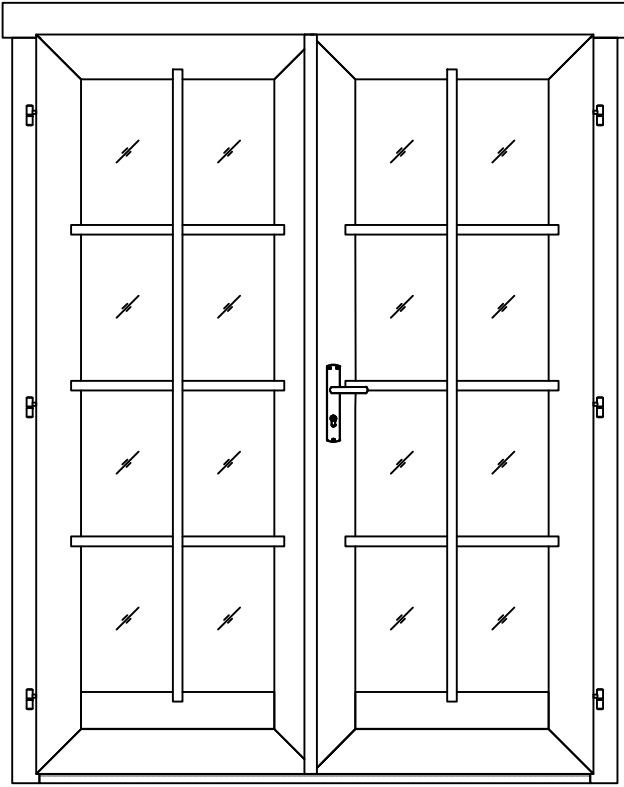
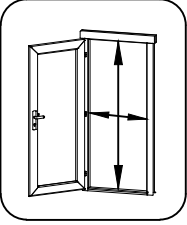
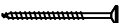
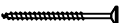
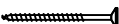
Pos	24.11.2017 Piece list - Stückliste - Liste des pièces - Elementi - Stuklijst - Tükitalabel 710x1224 AK.1.106.TSSP SGC	1/1	Q	P (mm)	L (mm)
	<p data-bbox="258 145 1292 174">Glass size - Glasgröße - Taille de la vitre - Misura del vetro - Glas afmeting - Klaasi mõõt: 566x1080 mm</p>   <p data-bbox="1369 342 1490 371">610x1124 mm</p>				
FS1	Window handle fittings - Fenstergriff - Poignée de fenetre - Maniglia c/ferramenta - Raamhendel -/grendel -/klink - Aknalink		2		
FSP	Bolt for window handle fittings - Bolzen für fenstergriff beschlag - Vis pour fixation poignée de fenetre - Bullone x apertura manuale finestra - Schroef voor raamhendel - Akna käepideme polt		4		
HS1	Screw for georgian bars - Schraube für sprossen - Vis pour croisillons - Viti per unire la griglia georgiana della finestra - Schroeven voor raamverdeling - Krugi akna petfeliistule		6	2.5x20	

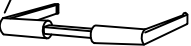
Pos	24.11.2017 Piece list - Stückliste - Liste des pièces - Elementi - Stuklijst - Tükítabel 710x1224 AK.1.106.TSSV SGC	1/1	Q	P (mm)	L (mm)
	<p data-bbox="260 152 1292 183">Glass size - Glasgröße - Taille de la vitre - Misura del vetro - Glas afmeting - Klaasi mõõt: 566x1080 mm</p>   <p data-bbox="1369 349 1490 376">610x1124 mm</p>				
FS1	<p data-bbox="260 1951 1023 2007">Window handle fittings - Fenstergriff - Poignée de fenetre - Maniglia c/ferramenta - Raamhendel -/grendel -/klink - Aknalink</p>			2	
FSP	<p data-bbox="260 2029 1102 2107">Bolt for window handle fittings - Bolzen für fenstergriff beschlag - Vis pour fixation poignée de fenetre - Bullone x apertura manuale finestra - Schroef voor raamhendel - Akna käepideme polt</p>			4	
HS1	<p data-bbox="260 2119 1107 2197">Screw for georgian bars - Schraube für sprossen - Vis pour croisillons - Viti per unire la griglia georgiana della finestra - Schroeven voor raamverdeling - Krugi akna petfeliistule</p>			6	2.5x20

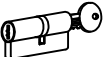
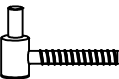
Pos	13.01.2017	Piece list - Stückliste - Liste des pièces - Elementi - Stuklijst - Tükitalabel 835x1900 UL.2.100.IVP.MMd TC	1/1	Q	P (mm)	L (mm)
		  <p>735x1818 mm</p>				
HS25	Screw for doorstep - Schrauben für swelle - Vis pour fixation barre de seuil - Vite per soglia della porta - Schroef voor deurdorpel - Kruvi lävepakule		2	4.5x65		
HS16	Screw for door jamb - Schraube für türrahmen - Vis de fixation partie haute avec montants du cadre de porte - Viti x fissaggio montanti porte - Schroef voor deurkozijn - Kruvi ukse lengile		4	5x90		
TL4	Door handle fittings - Türgriff - Poignée de porte - Maniglie - Deurhendel / klink - Ukse käepide		1			
TL5	Set of door lock covers - Schlossblenden - Set de garnitures de porte - Copertura serrature - Slot sluitplaat set - Ukse lukuplaat		1			
	Cylinder lock - Zylinderschloss - Barillet de porte - Serratura - Cylinder slot - Ukse lukusüdamik		1	30x35		
	Male bolt hinge for door - Türband - Partie male de paumelle de porte - Cerniera anube x porta - Scharnier bout - Ukse polthing isane		3			

Pos	24.11.2017 Piece list - Stückliste - Liste des pièces - Elementi - Stuklijst - Tükítabel 1494x1957 TUK.1.108.TSVP.MMb SGC	1/1	Q	P (mm)	L (mm)
	Glass size - Glasgröße - Taille de la vitre - Misura del vetro - Glas afmeting - Klaasi mõõt: 514x1593 mm				
	  <p>1394x1873 mm</p>				
HS1	Screw for georgian bars - Schraube für sprossen - Vis pour croisillons - Viti per unire la griglia georgiana della finestra - Schroeven voor raamverdeling - Kruvi ukse peffeliistule		16	2.5x20	
HS4	Screw for door fillet - Schraube zur befestigung türleiste - Vis pour fixation baguette d'arret de porte - Viti per massellino della porta - Schroef voor deurlijst - Kruvi ukse kokkuvaltšiliistule		5	3x30	
HS16	Screw for door jamb - Schraube für türrahmen - Vis de fixation partie haute avec montants du cadre de porte - Viti x fissaggio montanti porte - Schroef voor deurkozijn - Kruvi ukse lengile		4	5x90	
HS25	Screw for doorstep - Schrauben für swelle - Vis pour fixation barre de seuil - Vite per soglia della porta - Schroef voor deurdorpel - Kruvi lävepakule		3	4.5x65	
TL4	Door handle fittings - Türgriff - Poignee de porte - Maniglie - Deurhendel / klink - Ukse käepide		1		
TL5	Set of door lock covers - Schlossblenden - Set de garnitures de porte - Copertura serrature - Slot sluitplaat set - Ukse lukuplaat		1		
	Cylinder lock - Zylinderschloss - Barillet de porte - Serratura - Cylinder slot - Ukse lukusüdamik		1	30x35	
	Male bolt hinge for door - Türband - Partie male de paumelle de porte - Cerniera anube x porta - Scharnier bout - Ukse polthing isane		6		
	Striker for barrel bolt - Hülse für grendelriegel - Gache au sol du targette - Boccola per fermo della porta - Huls voor vergrendelingsschuif - Vasturaud ukse servariivile		2		