

*Bordeaux 44*  
*Art. Nr. 4415650*  
*1/6*

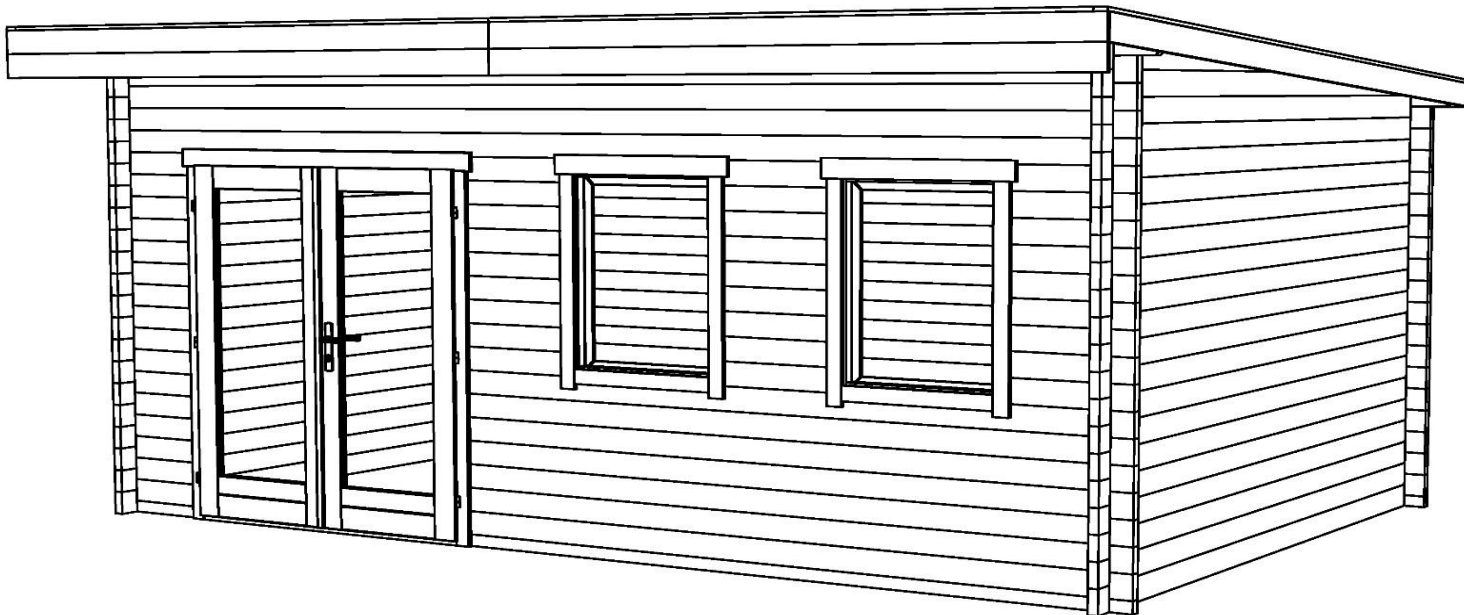

Art. Nr. 4415650

Groundplan - Grundplan - Plan de masse - Planimetria - Plattegrond - Põhiplaan

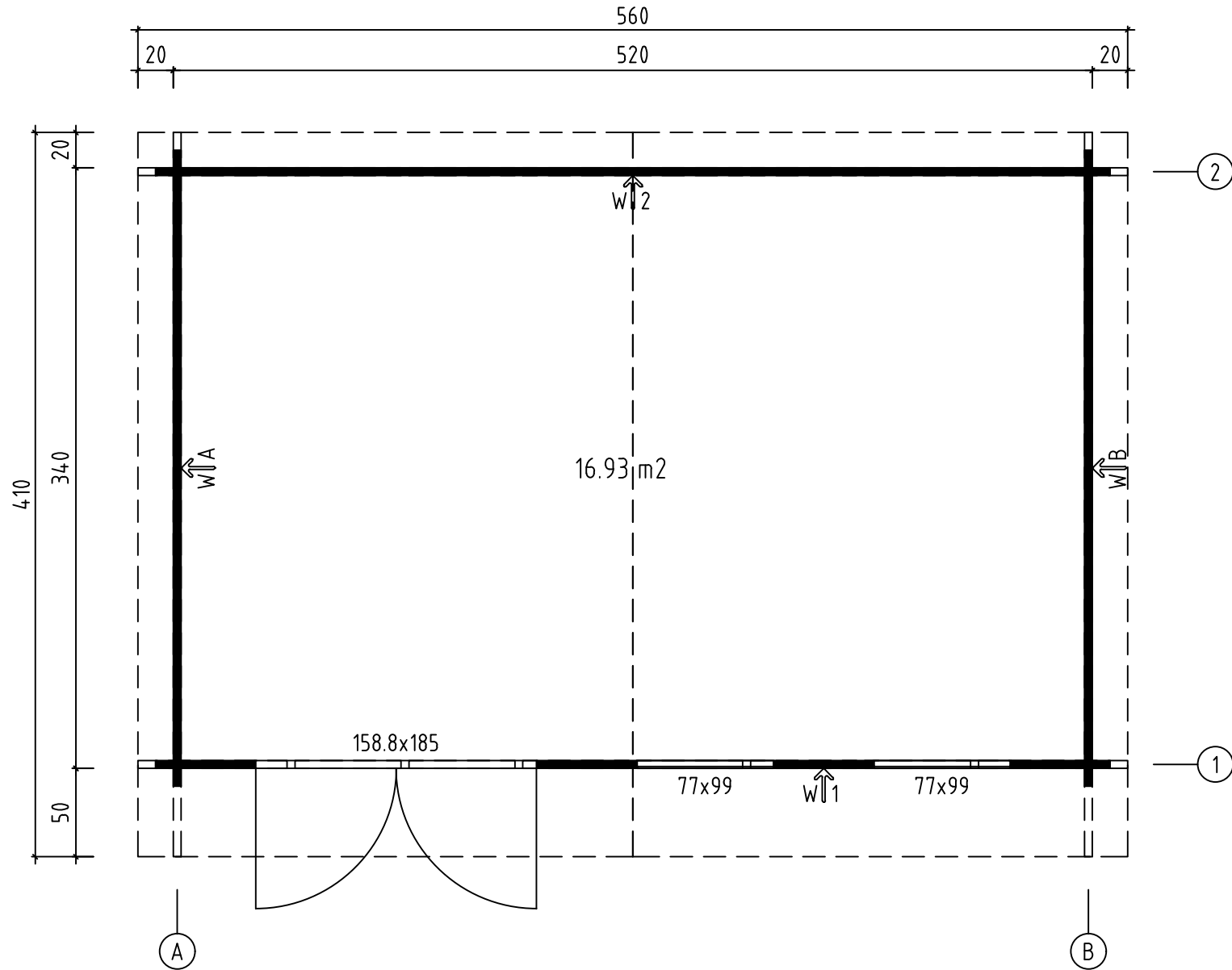









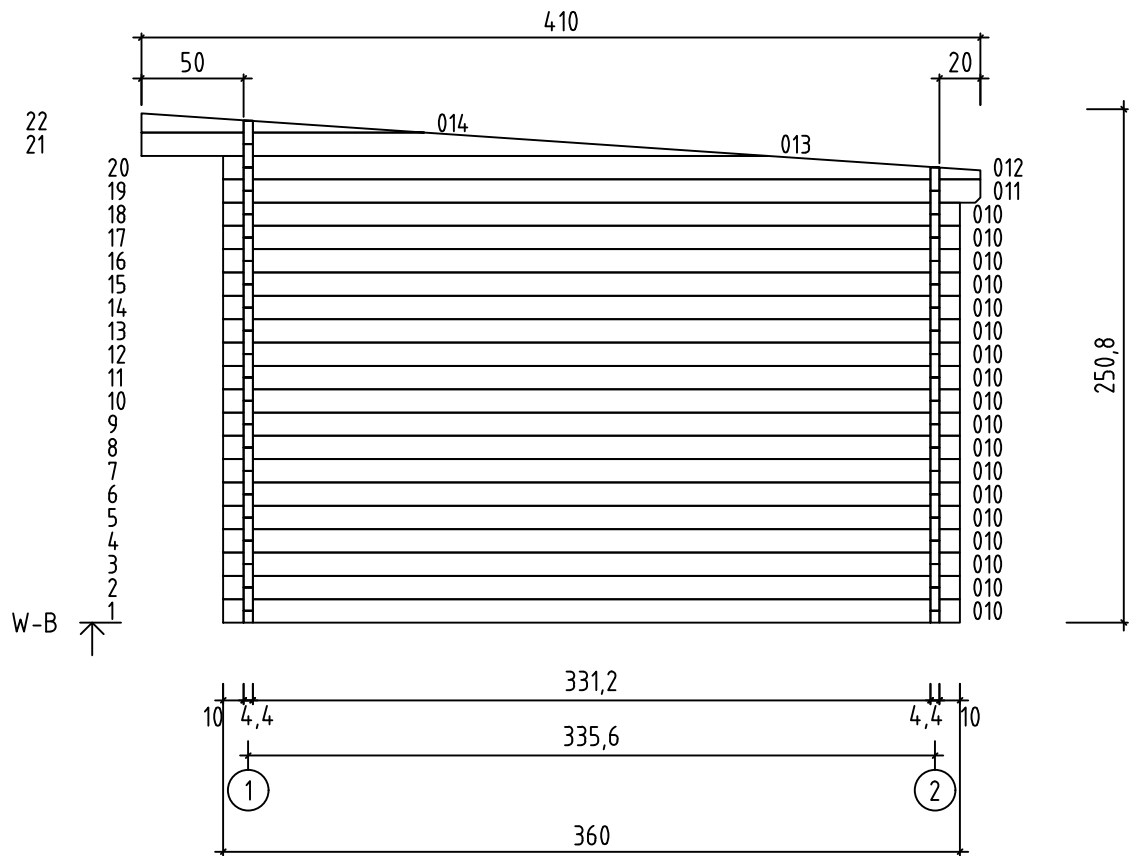
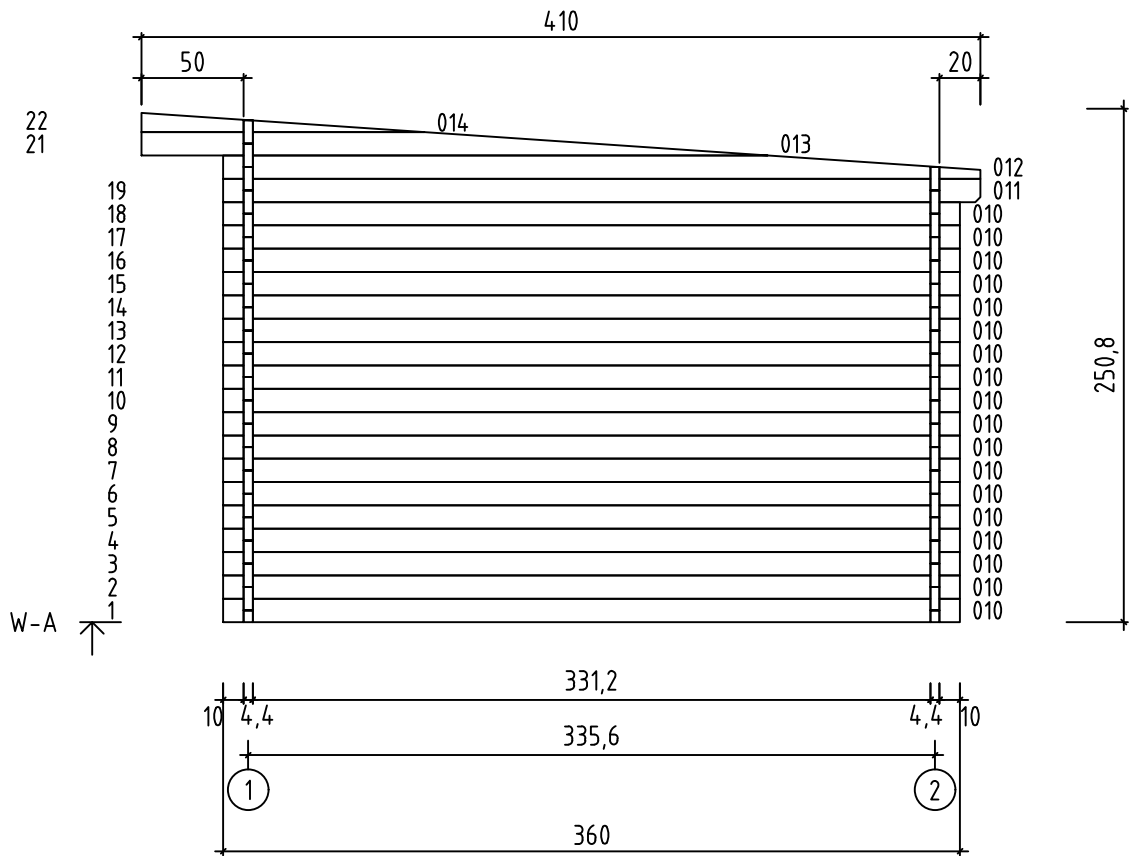



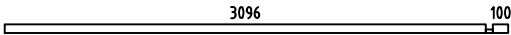

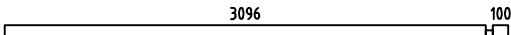

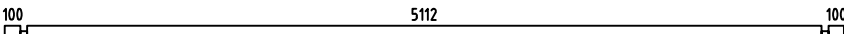
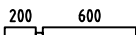

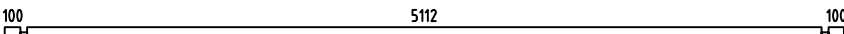
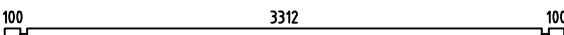
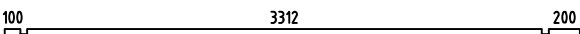
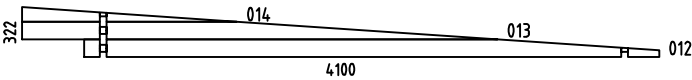
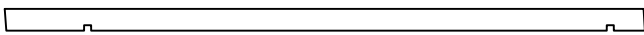
26.01.2021

2/6





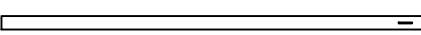

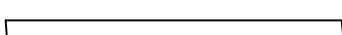

Art. Nr. 4415650

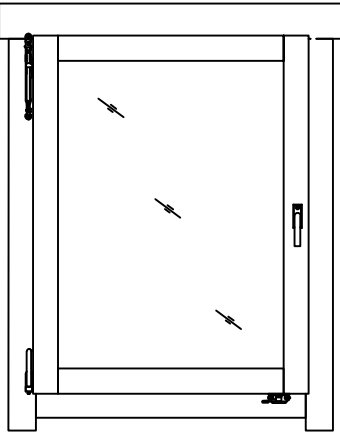
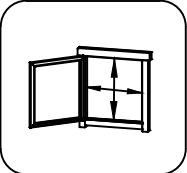
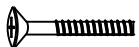

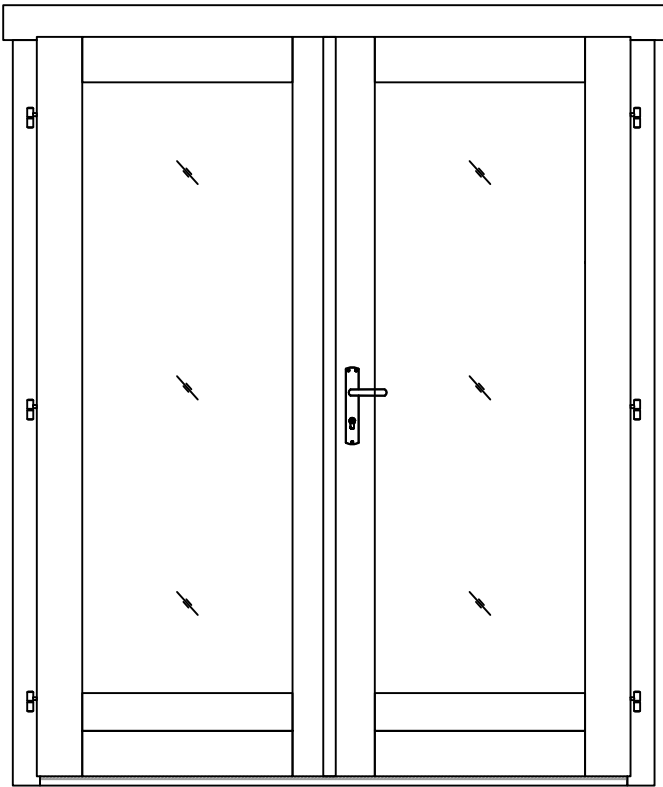
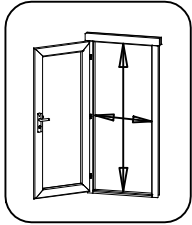
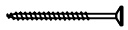
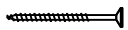
Pos	26.01.2021 Piece list - Stückliste - Liste des pièces - Elementi - Stuklijst - Tükítabel Art. Nr. 4415650 5/6	Q	P (mm)	L (mm)
001		1	44x57	560
002		1	44x57	3240
003		25	44x114	560
004		7	44x114	3240
005		18	44x114	560
006		22	44x114	5400
007		4	44x114	844
008		12	44x114	600
009		1	44x57	5400
010		36	44x114	3600
011		2	44x114	3700
WA-1 WB-1		1 1		
SR1	Rafter - Dachsparren - Chevron - Trave - Dak spar - Sarikas 	7	44x140	4119
	Roof boards - Dachbretter - Voliges - Perlina per tetto - Dakhout - Katuselaud 	92	90x18	2800
	Roofing felt fillet - Dachpappenleiste - Baguette de fixation du feutre bitumeux - Asse per fissaggio guaina bituminosa - Afdekljst asfaltpapier - Katusepapiilist 	2	18x58	2760
	Roofing felt fillet - Dachpappenleiste - Baguette de fixation du feutre bitumeux - Asse per fissaggio guaina bituminosa - Afdekljst asfaltpapier - Katusepapiilist 	2	18x58	4146
DPP-1	Roofing felt (strip) - Dachpappe (bahnen) - Feutre bitumeux (bande) - Cartone catramato - Asfaltpapier (baan) - Katusepapp 	5		5700
DRV-1	Roof edge reinforcement - Dachrandverstärkung - Corniere de renfort de bord de toit - Rinforzo x tetto - Dakrand versterking - Räästatugevdus 	2	28x34	200
DRV-2	Roof edge reinforcement - Dachrandverstärkung - Corniere de renfort de bord de toit - Rinforzo x tetto - Dakrand versterking - Räästatugevdus 	2	28x34	500
DRV-3	Roof edge reinforcement - Dachrandverstärkung - Corniere de renfort de bord de toit - Rinforzo x tetto - Dakrand versterking - Räästatugevdus 	2	28x34	3320
KFS-1	Storm protection - Sturmleiste - Latte anti-tempete - Protezione anti vento - Stormverankering / beveiliging - Tormikinnitusliist 	4	22x45	2500
	Gable moulding - Giebelleiste - Planche de rive - Finitura per frontale e retro del tetto - Gevellijst - Viilulaud 	6	18x120	2818
	Gable moulding - Giebelleiste - Planche de rive - Finitura per frontale e retro del tetto - Gevellijst - Viilulaud 	2	18x120	4119

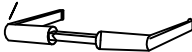

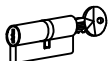
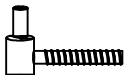
Pos	20.09.2018 Piece list - Stückliste - Liste des pièces - Elementi - Stuklijst - Tükítabel 770x990 AK.1.100.PSV.† DGP	1/1	Q	P (mm)	L (mm)
	<p data-bbox="268 152 1284 183">Glass size - Glasgröße - Taille de la vitre - Misura del vetro - Glas afmeting - Klaasi mõõt: 600x812 mm</p>   <p data-bbox="1369 347 1492 376">670x902 mm</p>				
FS1	<p data-bbox="268 2042 1024 2101">Window handle fittings - Fenstergriff - Poignee de fenetre - Maniglia c/ferramenta - Raamhendel -/grendel -/klink - Aknalink</p>		1		
FSP	<p data-bbox="268 2123 1104 2199">Bolt for window handle fittings - Bolzen für fenstergriff beschlag - Vis pour fixation poignee de fenetre - Bullone x apertura manuale finestra - Schroef voor raamhendel - Akna käepideme polt</p>		2		

Pos	20.09.2018	Piece list - Stückliste - Liste des pièces - Elementi - Stuklijst - Tükitalabel 1588x1850 TUK.1.100.PVP.MMa DGP	1/1	Q	P (mm)	L (mm)
		<p>Glass size - Glasgröße - Taille de la vitre - Misura del vetro - Glas afmeting - Klaasi mõõt: 561x1486 mm</p>   <p>1488x1766 mm</p>				
HS4	Screw for door fillet - Schraube zur Befestigung Türleiste - Vis pour fixation baguette d'arrêt de porte - Viti per massellino della porta - Schroef voor deurlijst - Kruvi ukse kokkuvältsiliistule		5	3x30		
HS16	Screw for door jamb - Schraube für Türrahmen - Vis de fixation partie haute avec montants du cadre de porte - Viti x fissaggio montanti porte - Schroef voor deurkozijn - Kruvi ukse lengile		4	5x90		
HS25	Screw for doorstep - Schrauben für swelle - Vis pour fixation barre de seuil - Vite per soglia della porta - Schroef voor deurdorpel - Kruvi lävepakule		3	4.5x65		
TL4	Door handle fittings - Türgriff - Poignée de porte - Maniglie - Deurhendel / klink - Ukse käepide		1			
TL5	Set of door lock covers - Schlossblenden - Set de garnitures de porte - Copertura serrature - Slot sluitplaat set - Ukse lukuplaat		1			
	Cylinder lock - Zylinderschloss - Barillet de porte - Serratura - Cylinder slot - Ukse lukusüdamik		1	30x35		
	Male bolt hinge for door - Türband - Partie male de paumelle de porte - Cerniera anube x porta - Scharnier bout - Ukse polthing isane		6			
	Striker for barrel bolt - Hülse für Grendelriegel - Gache au sol du targette - Boccola per fermo della porta - Huls voor vergrendelingsschuif - Vasturaud ukse servariivile		2			