

The Haven
Art. Nr. 4417102
1/10

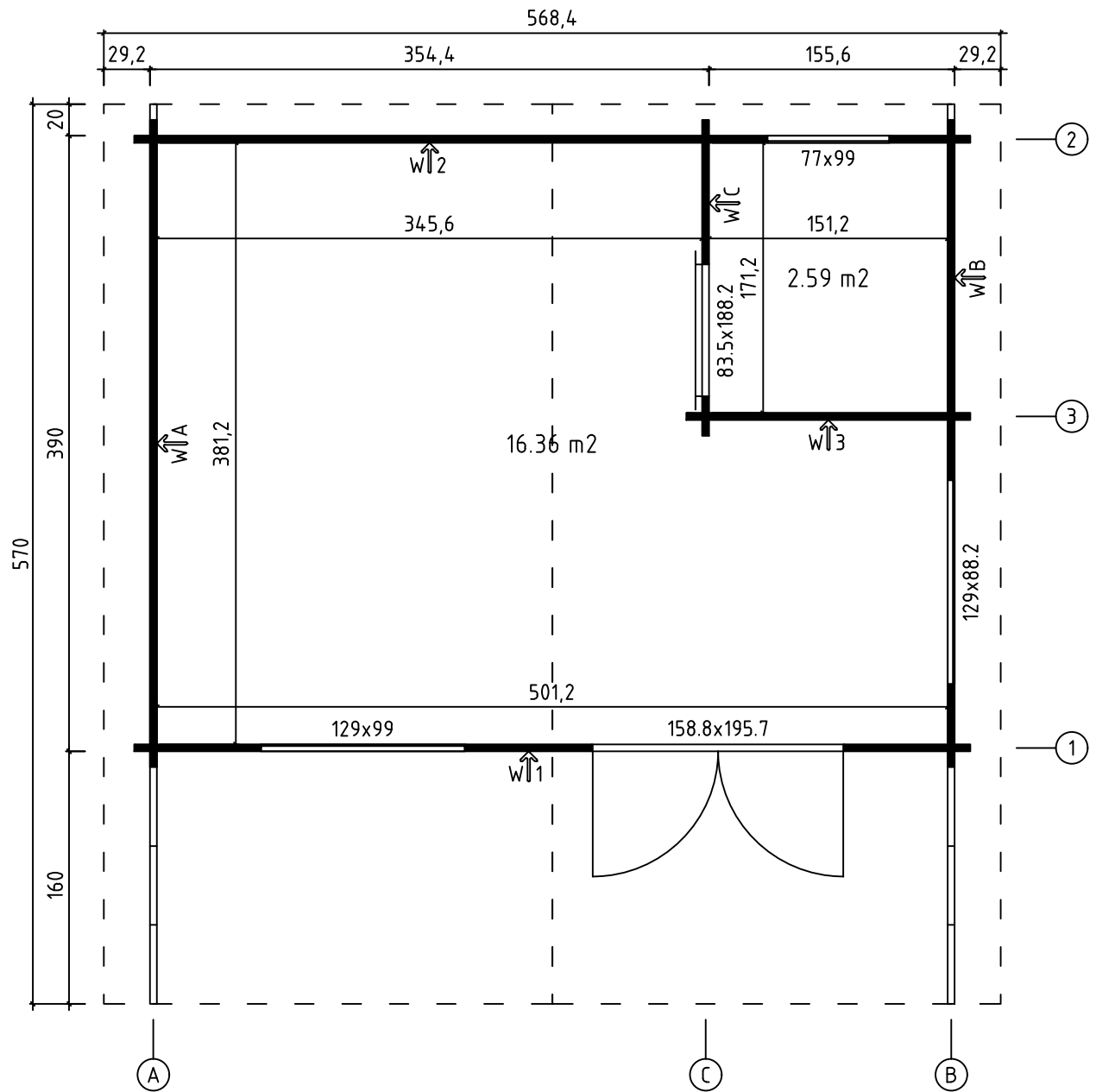

Art. Nr. 4417102

Groundplan - Grundplan - Plan de masse -
Planimetria - Plattegrond - Põhiplaan



Art. Nr. 4417102

Foundation - Fundament - Fondation -
Fondamenta - Fundering - Immutatud alusraam

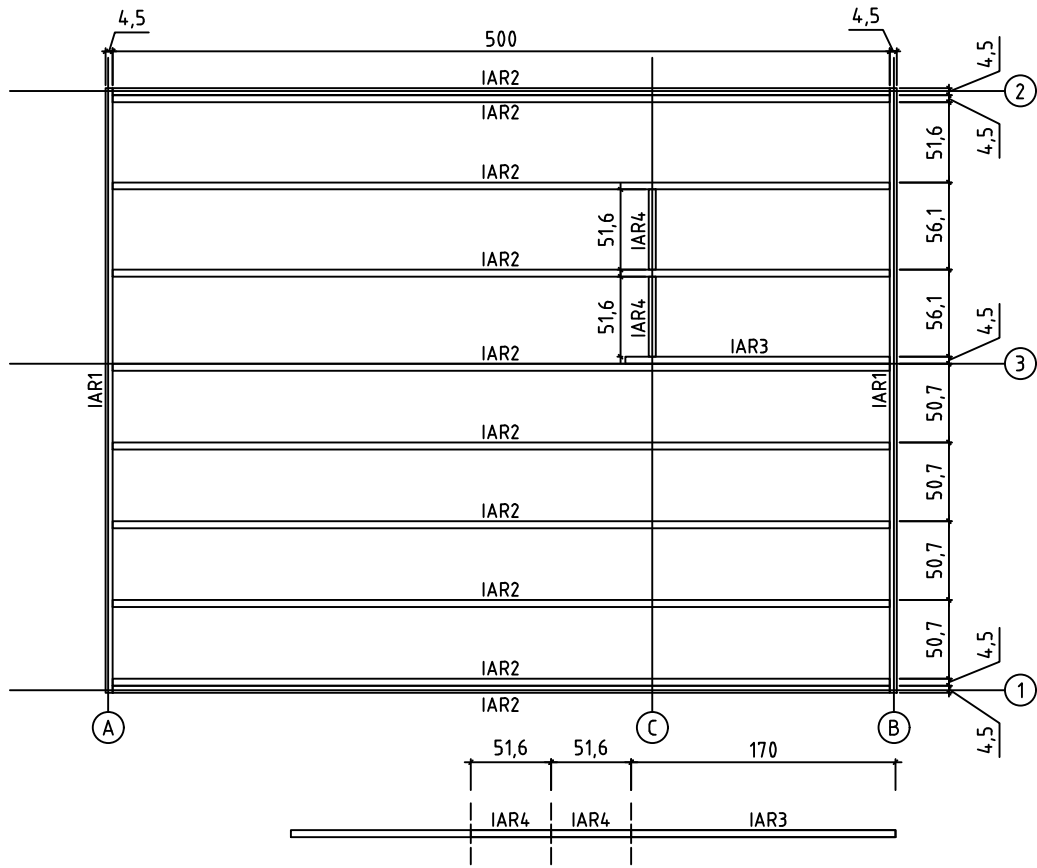

Floor boards - Fussbodenbretter - Plan pose plancher -
Pavimento - Vloerhout - Põrandalaudis

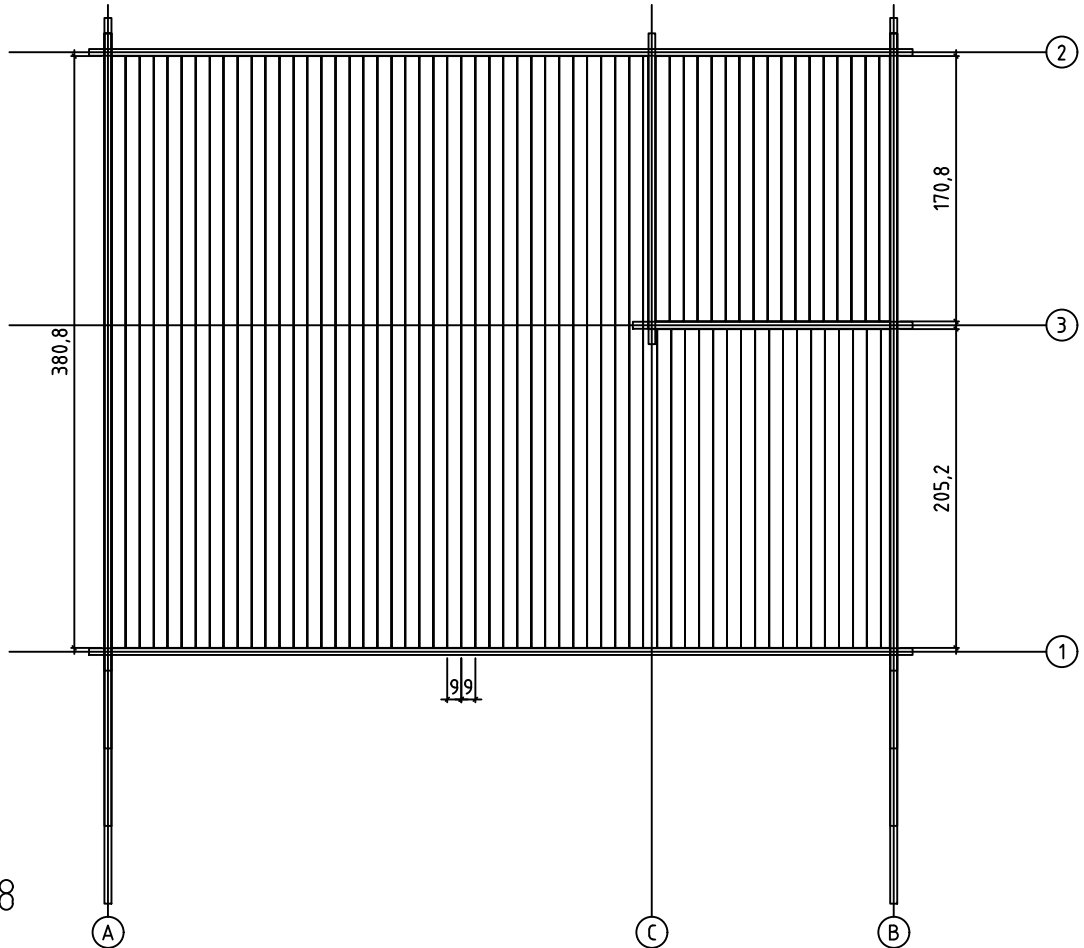

05.11.2018

3/10

Art. Nr. 4417102

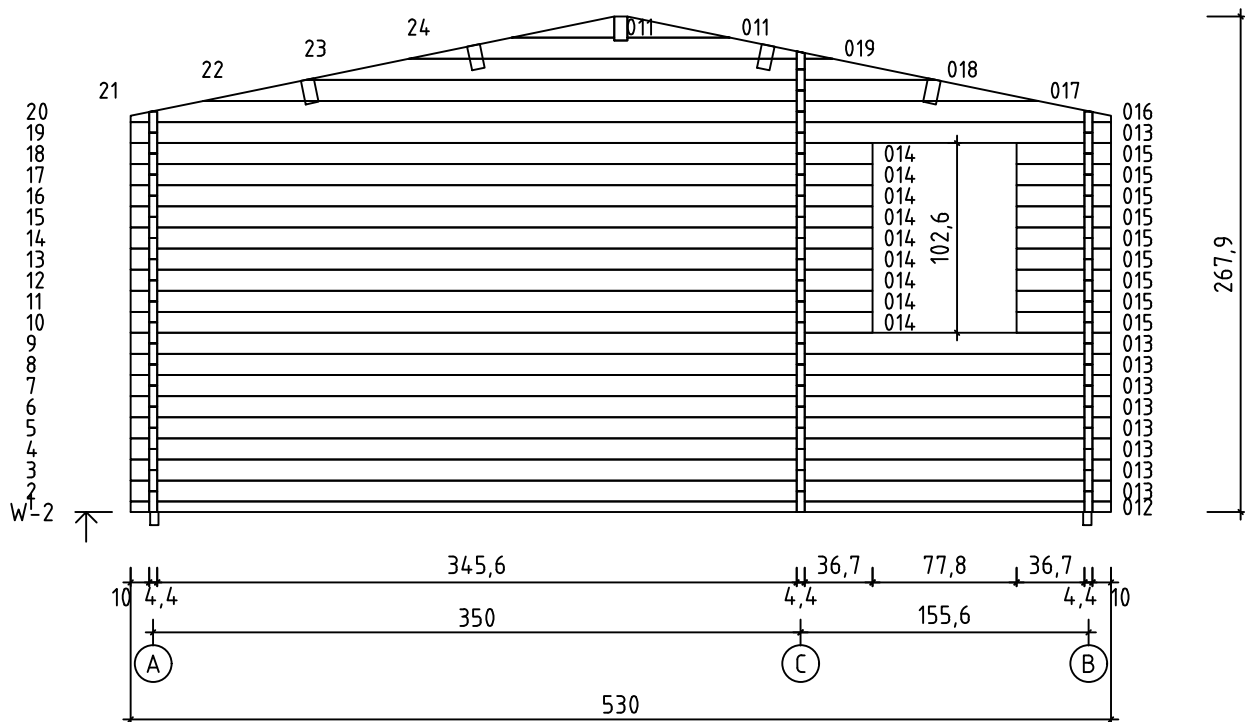
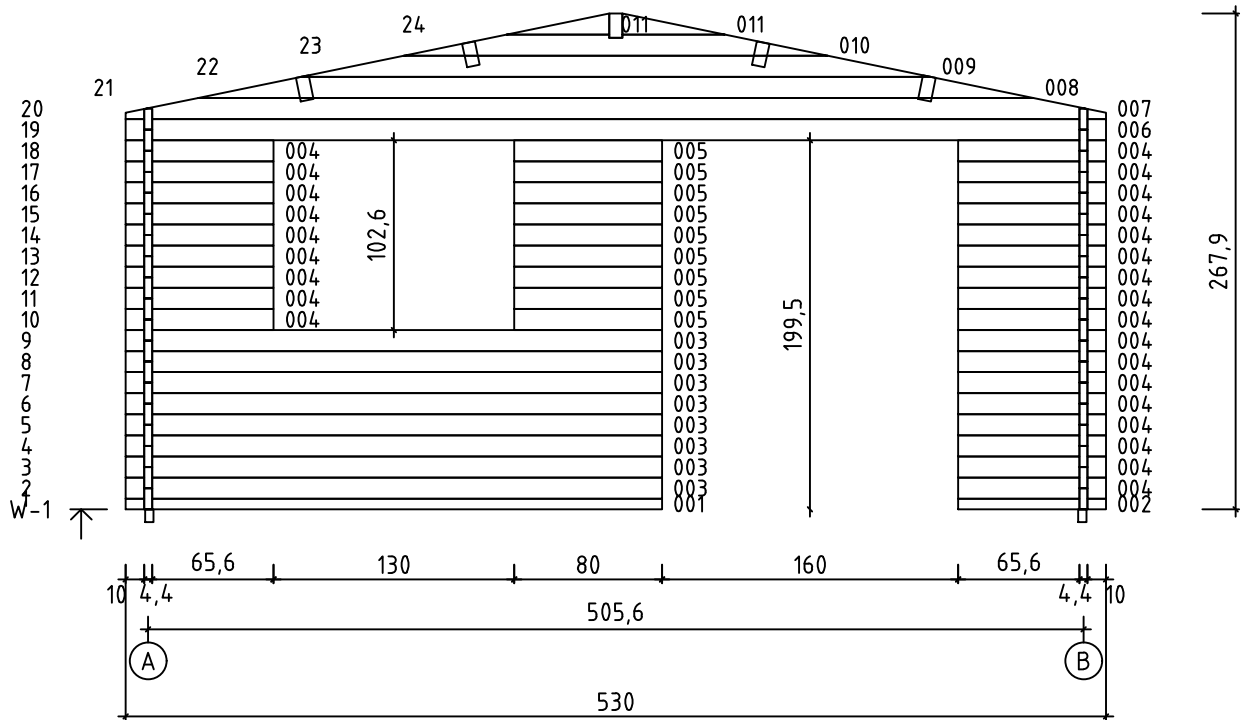



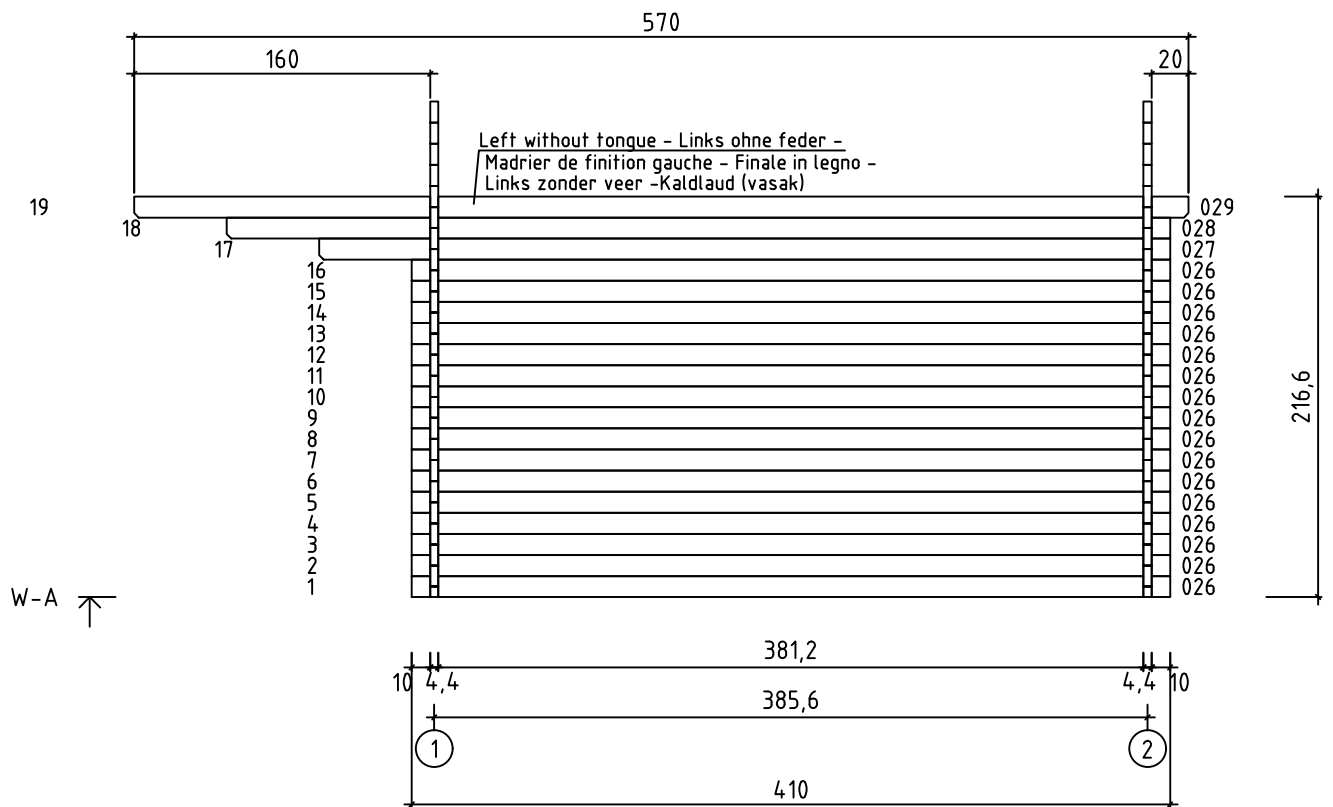
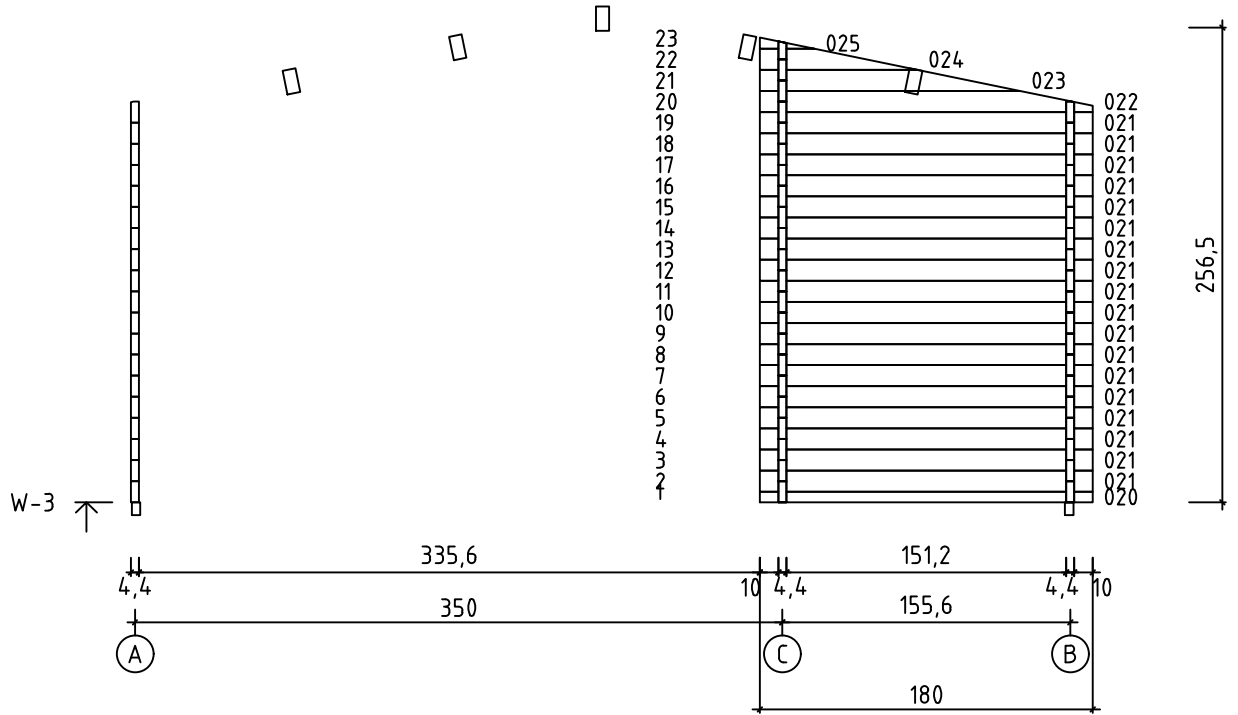



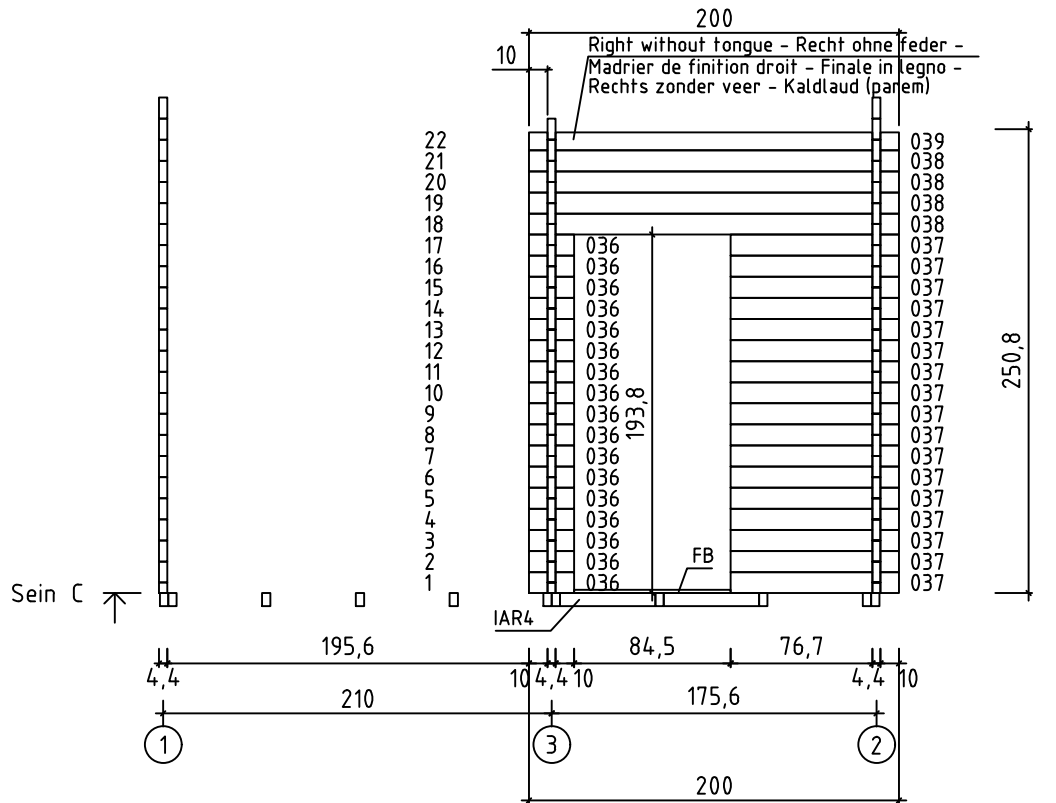
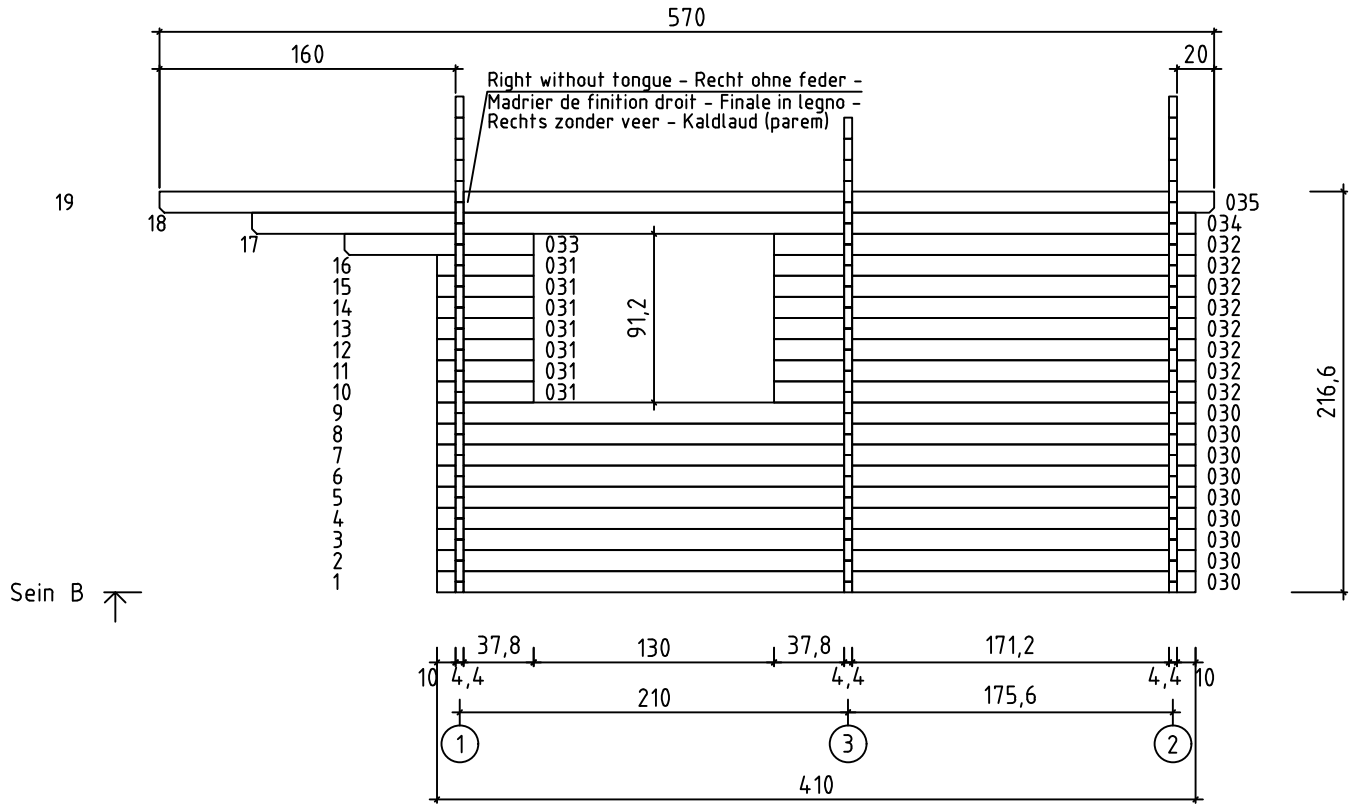

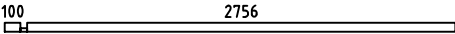
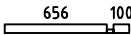
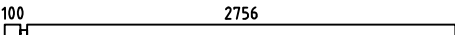
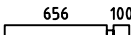
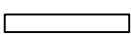
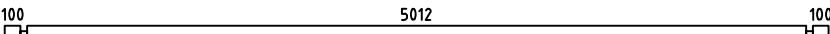
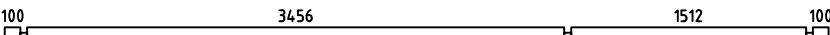
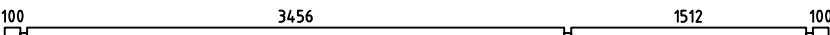
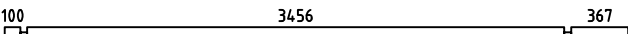

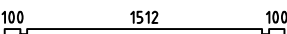
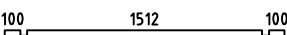
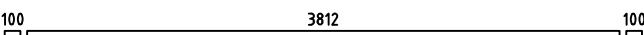





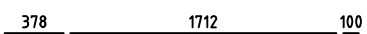

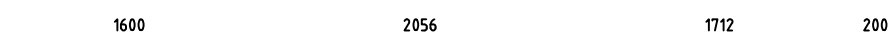

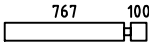
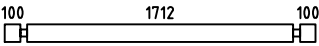
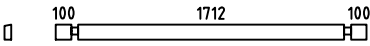
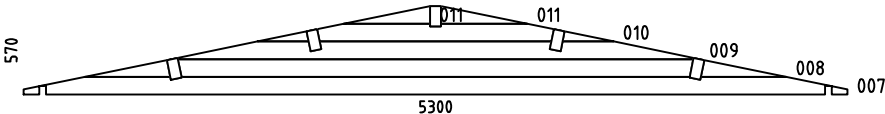
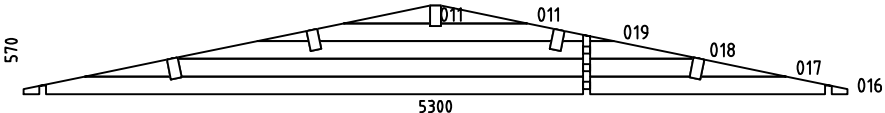
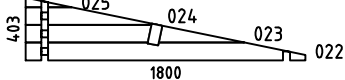
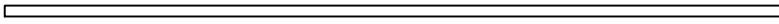
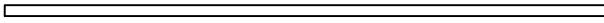
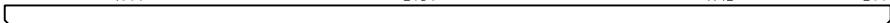
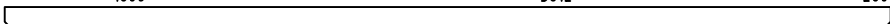

Art. Nr. 4417102



Art. Nr. 4417102



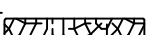

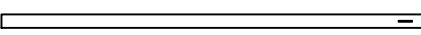
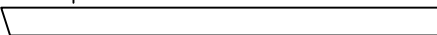

Pos	05.11.2018 Piece list - Stückliste - Liste des pièces - Elementi - Stuklijst - Tükítabel Art. nr. 4417102 7/10	Arv	Profiil (mm)	Pikkus (mm)
001		1	44x57	2900
002		1	44x57	800
003		8	44x114	2900
004		26	44x114	800
005		9	44x114	800
006		1	44x114	5300
012		1	44x57	5300
013		9	44x114	5300
014		9	44x114	4011
015		9	44x114	511
020		1	44x57	1800
021		18	44x114	1800
026		16	44x114	4100
027		1	44x114	4600
028		1	44x114	5100
029		1	44x120	5700
030		9	44x114	4100
031		7	44x114	522
032		8	44x114	2278
033		1	44x114	1022
034		1	44x114	5100
035		1	44x120	5700
036		17	44x114	244

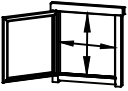
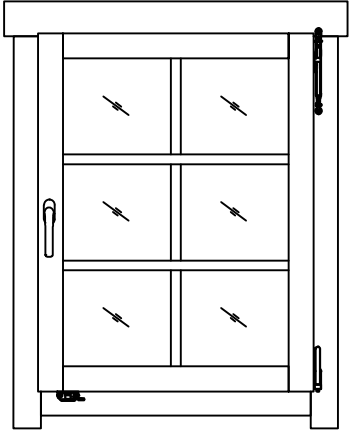
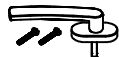
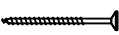

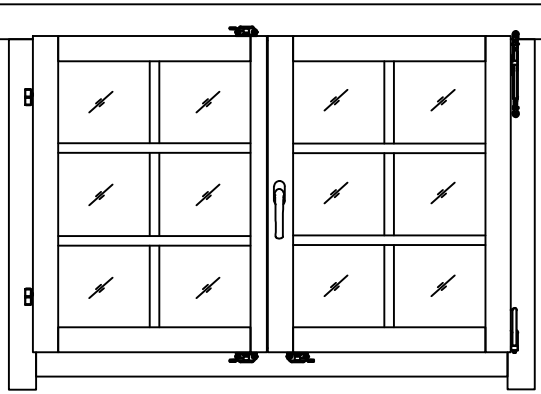
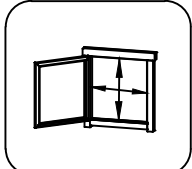
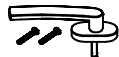

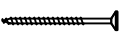

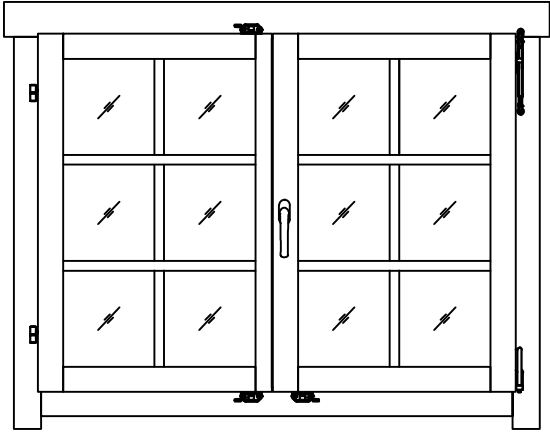
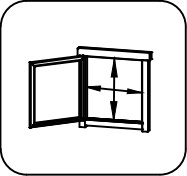
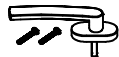
Pos	05.11.2018 Piece list - Stückliste - Liste des pièces - Elementi - Stuklijst - Tükitalabel Art. nr. 4417102 8/10	Arv	Profiil (mm)	Pikkus (mm)
037		17	44x114	911
038		4	44x114	2000
039		1	44x97	2000
W1-1		1		
W2-1		1		
W3-1		1		
IAR2	Foundation - Fundament - Fondation - Fondamenta - Fundering - Immutatud alusraam 	10	45x70	5000
IAR1	Foundation - Fundament - Fondation - Fondamenta - Fundering - Immutatud alusraam 	3	45x70	3890
A-PR2	Roof beam - Dachbalken - Panne de toit - Perlina del tetto - Gordingen / dakbalk - Pärilin 1600 2056 1712 200 	1	70x140	5700
A-PR1	Roof beam - Dachbalken - Panne de toit - Perlina del tetto - Gordingen / dakbalk - Pärilin 1600 3812 200 	4	70x140	5700
FB	Floor boards - Fussbodenbretter - Lame de plancher - Pavimento - Vloerhout - Põrandalaud 	39	90x18	3808
FB	Floor boards - Fussbodenbretter - Lame de plancher - Pavimento - Vloerhout - Põrandalaud 	17	90x18	2052
FB	Floor boards - Fussbodenbretter - Lame de plancher - Pavimento - Vloerhout - Põrandalaud 	18	90x18	1708
	Roof boards - Dachbretter - Voliges - Perlina per tetto - Dakhout - Katuselaud 	128	90x18	2900
	Floor fillet - Fussbodenteiste - Corniere de finition du plancher - Finitura per pavimento (battisco pa) - Vloerafwerklijst - Põrandaliist 		18x18	24.06
TS1	Rail holder for sliding door - Schiene für schiebetür, oben - Rail support pour porte coulissante - Supporto per porta scorrevole - Rails houder voor schuifdeur - Lükandukse kinniti 	1	28x34	1500
TS2	Rail holder cover for sliding door - Schiene für schiebetür, oben - Le couvrir de rail support pour porte coulissante - Supporto di copertura per porta scorrevole - Rails houder afdekkap voor schuifdeur - Lükandukse kinniti kate 	2	18x80	52
TS3	Rail holder cover for sliding door - Schiene für schiebetür, oben - Le couvrir de rail support pour porte coulissante - Supporto di copertura per porta scorrevole - Rails houder afdekkap voor schuifdeur - Lükandukse kinniti kate 	1	18x80	1500
TB-1	Fascia board - Traufbrett - Bandeau de toit - Finitura lati tetto - Gevellijst - Räästalaud 	4	18x90	2850
DRV-1	Roof edge reinforcement - Dachrandverstärkung - Corniere de renfort de bord de toit - Rinforzo x tetto - Dakrand versterking - Räästatugevdus 	4	28x34	2850
KFS-1	Storm protection - Sturmleiste - Latte anti-tempete - Protezione anti vento - Stormverankering / beveiliging - Tormikinnitusliist 	4	22x45	2500
	Gable moulding - Giebelleiste - Planche de rive - Finitura per frontale e retro del tetto - Gevellijst - Viilulaud 	4	18x120	2950

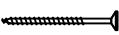

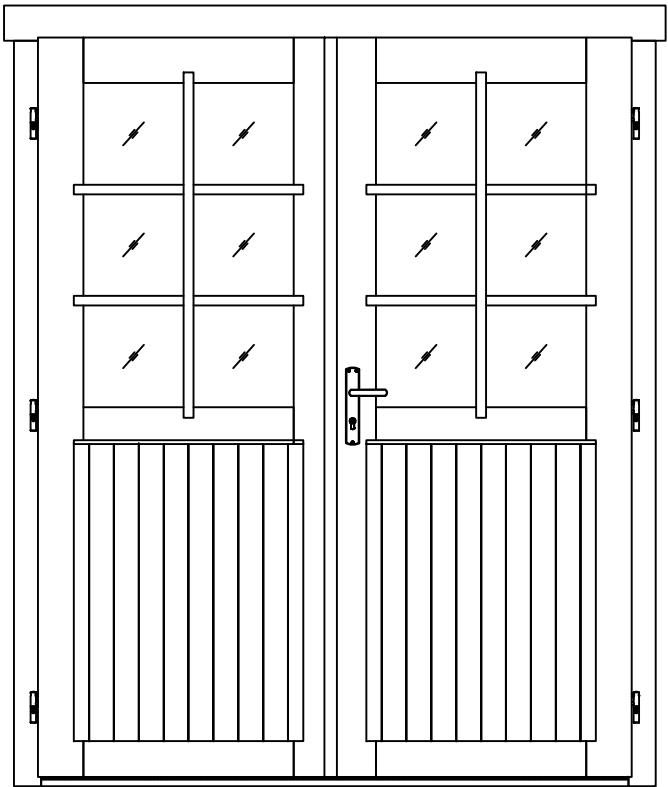
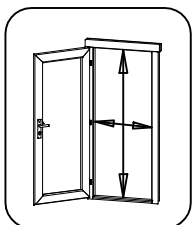
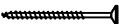
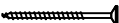
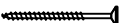
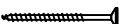



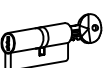

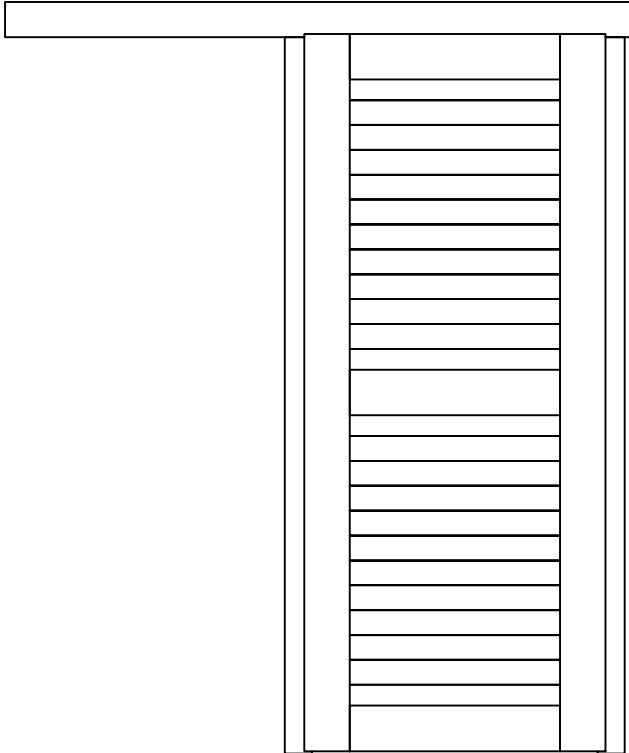
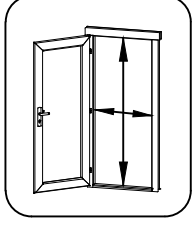

Pos	05.11.2018 Piece list - Stückliste - Liste des pièces - Elementi - Stuklijst - Tükítabel Art. nr. 4417102 9/10	Q	P (mm)	L (mm)
HS8	Screw for gable segment - Schrauben für deckblatt - Vis pour fixation losange de finition - Viti x frontali tetto - Schroef voor gevelpunt segment - Kruvi rombile 	4	3.5x35	
HS9	Screw for gable moulding - Schrauben für giebelleiste - Vis pour fixation planche de rive - Vite per fissare finitura davanti e dietro del tetto - Schroef voor gevellijst - Kruvi viilulauale 	32	3.5x50	
HS12	Screw for fascia boards - Schrauben für traufbretter - Vis pour fixation bandeau de toit - Viti x striscia del tetto - Schroef voor gevellijst - Kruvi räästalaualae 	28	4x40	
HS12	Screw for roof edge reinforcement - Schrauben für dachrandverstärkung - Vis pour fixation corniere renfort de bord de toit - Viti x rinforzo bordo tetto - Schroef voor dakrand versterking - Kruvi räästatugevdusele 	28	4x40	
HS18	Screw for roof beams - Schrauben für dachbalken - Vis pour fixation pannes de toit - Viti per perline del tetto - Schroef voor gordingen / dakbalken - Kruvi pärlinitele 	11	5x120	
HS18	Screw for gable - Schrauben für giebel - Vis pour fixation des pignons - Viti per timpano - Schroef voor gevelpunt - Kruvi viilude kinnitamiseks 	7	5x120	
HS16	Screw for 1. wall beam - Schraube für 1. bohlenreihe - Vis de fixations 1ere rangée de madriers avec poutrelles de fondations - Vite fissaggio alle fondamenta - Schroef voor 1 wandbalk - Kruvi poolalauale 	8	5x90	
HS16	Screw for foundation - Schrauben zur befestigung fundament - Vis de fixations des poutrelles de fondations - Viti x fondamenta - Schroef voor fundering - Kruvi alusraamile 	26	5x90	
HS16	Screw for foundation - Schrauben zur befestigung fundament - Vis de fixations des poutrelles de fondations - Viti x fondamenta - Schroef voor fundering - Kruvi alusraamile 	8	5x90	
NF2	Zn nail for floor fillet - Zn nägel für fussbodenleiste - Pointe pour corniere de finition du plancher - Chiodi x fissaggio pavimento - Spijker(nagel) voor vloer afdekljst - Nael põrandaliistule 	49	1.4x40	
SH44	Hammer block - Schlagholz - Calle de frappe - Blocco di legno da usare come cuscinetto quando si usa il martello - Slagklos - Löögiklots 	1		
SFS	Nut for storm protection - Schraubenmutter für sturmleiste - Ecrou pour latte anti-tempete - Dado x asta protezione vento - Moer voor stromverankering - Mutter tormikinnitusliistule 	8	D8	
NF4	Zn nail for roof - Zn nägel für dachbretter - Pointe pour fixation voliges de toit - Chiodi x perline tetto - Spijker(nagel) voor dakhout - Nael katuselauale 	554	2x50	
NF4	Zn nail for floor - Zn nägel für fussbodenbretter - Clous pour plancher - Chiodi x perline pavimento - Spijker(nagel) voor vloer - Nael põrandalauale 	482	2x50	
BFS	Bolt for storm protection - Bolzen für sturmleiste - Boulon pour latte anti-tempete - Bullone x asta protezione vento - Bout voor stormankerlat - Puidupolt tormikinnitusliistule 	8	8x80	
GS	Gable segment - Deckblatt - Losange de finition - Decorazione in legno x frontale tetto - Gevelpunt segment - Romb 	2		
DFS	Washer for storm protection - Dichtscheibe für sturmleiste - Rondelle pour latte anti-tempete - Rondella x asta protezione vento - Afdichtring voor storm strip - Seib tormikinnitusliistule 	8	D8	
	Torx bit - Schraubendrehereinsatz - Embout pour tournevis - Punte per cacciaviti e chiavi a stella - Torx schroef (bit) - Torx kruviotsik 	1	TX-10	
	Torx bit - Schraubendrehereinsatz - Embout pour tournevis - Punte per cacciaviti e chiavi a stella - Torx schroef (bit) - Torx kruviotsik 	1	TX-15	
	Torx bit - Schraubendrehereinsatz - Embout pour tournevis - Punte per cacciaviti e chiavi a stella - Torx schroef (bit) - Torx kruviotsik 	1	TX-20	
	Torx bit - Schraubendrehereinsatz - Embout pour tournevis - Punte per cacciaviti e chiavi a stella - Torx schroef (bit) - Torx kruviotsik 	1	TX-25	
	Window - Fenster - Fenetre - Finestra - Raam - Aken 770x990 AK.1.106.TPSP.c DGP+	1		
	Window - Fenster - Fenetre - Finestra - Raam - Aken 1290x882 TAK.1.106.TPSP.a DGP+	1		

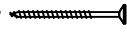
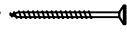
Pos	07.06.2018 Piece list - Stückliste - Liste des pièces - Elementi - Stuklijst - Tükitalabel 770x990 AK.1.106.TPSP.c DGP+	1/1	Q	P (mm)	L (mm)
	<p data-bbox="263 152 1284 190">Glass size - Glasgröße - Taille de la vitre - Misura del vetro - Glas afmeting - Klaasi mõõt: 600x618 mm</p> <div data-bbox="1337 152 1524 331" style="border: 1px solid black; border-radius: 10px; padding: 5px; display: inline-block;">  </div> <p data-bbox="1364 347 1492 380" style="text-align: center;">670x894 mm</p> <div data-bbox="678 488 1029 918" style="text-align: center;">  </div>				
FS2	<p data-bbox="263 2038 1021 2094">Window handle fittings - Fenstergriff - Poignee de fenetre - Maniglia c/ferramenta - Raamhendel -/grendel -/klink - Aknalink</p>		1		
HS1	<p data-bbox="263 2116 1109 2195">Screw for georgian bars - Schraube für sprossen - Vis pour croisillons - Viti per unire la griglia georgiana della finestra - Schroeven voor raamverdeling - Kruvi akna petfeliistule</p>		6	2.5x20	

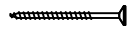
Pos	27.11.2017 Piece list - Stückliste - Liste des pièces - Elementi - Stuklijst - Tükítabel 1290x882 TAK.1.106.TPSP.a DGP+	1/1	Q	P (mm)	L (mm)
	<p data-bbox="263 156 1284 190">Glass size - Glasgröße - Taille de la vitre - Misura del vetro - Glas afmeting - Klaasi mõõt: 515x704 mm</p>   <p data-bbox="1364 347 1492 380">1190x786 mm</p>				
FS2	Window handle fittings - Fenstergriff - Poignée de fenetre - Maniglia c/ferramenta - Raamhendel -/grendel -/klink - Aknalink		1		
HS1	Screw for georgian bars - Schraube für sprossen - Vis pour croisillons - Viti per unire la griglia georgiana della finestra - Schroeven voor raamverdeling - Kruvi akna petteliistule		12	2.5x20	
HS4	Screw for window fillet - Schraube für glasleiste - Vis de filet de fenetre - Vite per assemblaggio finestra - Schroef voor glaslijst - Kruvi akna kokkuvaltšiliistule		3	3x30	

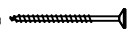
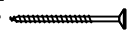
Pos	07.06.2018 Piece list - Stückliste - Liste des pièces - Elementi - Stuklijst - Tükítabel 1290x990 TAK.1.106.TPSP.b DGP+	1/1	Q	P (mm)	L (mm)
	<p data-bbox="263 152 1284 190">Glass size - Glasgröße - Taille de la vitre - Misura del vetro - Glas afmeting - Klaasi mõõt: 515x812 mm</p>   <p data-bbox="1364 347 1492 380">1190x894 mm</p>				
FS2	Window handle fittings - Fenstergriff - Poignée de fenetre - Maniglia c/ferramenta - Raamhendel -/grendel -/klink - Aknalink		1		
HS1	Screw for georgian bars - Schraube für sprossen - Vis pour croisillons - Viti per unire la griglia georgiana della finestra - Schroeven voor raamverdeling - Kruvi akna petteliistule		12	2.5x20	
HS4	Screw for window fillet - Schraube für glasleiste - Vis de filet de fenetre - Vite per assemblaggio finestra - Schroef voor glaslijst - Kruvi akna kokkuvaltšiliistule		3	3x30	

Pos	07.06.2018	Piece list - Stückliste - Liste des pièces - Elementi - Stuklijst - Tükitalabel 1588x1957 TUK.2.056.TPVP.MMW DGP+	1/1	Q	P (mm)	L (mm)
		Glass size - Glasgröße - Taille de la vitre - Misura del vetro - Glas afmeting - Klaasi mõõt: 561x855 mm				
		 				
HS1	Screw for georgian bars - Schraube für sprossen - Vis pour croisillons - Viti per unire la griglia georgiana della finestra - Schroeven voor raamverdeling - Kruvi ukse petteliistule		12	2.5x20		
HS4	Screw for door fillet - Schraube zur befestigung türleiste - Vis pour fixation baguette d'arret de porte - Viti per massellino della porta - Schroef voor deurlijst - Kruvi ukse kokkuvalt siliistule		5	3x30		
HS16	Screw for door jamb - Schraube für türrahmen - Vis de fixation partie haute avec montants du cadre de porte - Viti x fissaggio montanti porte - Schroef voor deurkozijn - Kruvi ukse lengile		4	5x90		
HS25	Screw for doorstep - Schrauben für swelle - Vis pour fixation barre de seuil - Vite per soglia della porta - Schroef voor deurdorpel - Kruvi lävepakule		3	4.5x65		
MH	Male bolt hinge for door - Türband - Partie male de paumelle de porte - Cerniera anube x porta - Scharnier bout - Reguleeritav polthing isane		6	14x80		
HC	Covers for door hinges - Schutzkappe für türband - Couverture de paumelle de porte - Copertura delle cerniere della porta - Afdek kap voor deurscharnier - Reguleeritava polthinge kate		12			
TL4	Door handle fittings - Türgriff - Poignee de porte - Maniglie - Deurhendel klink - Ukse käepide		1			
TL5	Set of door lock covers - Schlossblenden - Set de garnitures de porte - Copertura serrature - Slot sluitplaat set - Ukse lukuplaat		1			
	Cylinder lock - Zylinderschloss - Barillet de porte - Serratura - Cylinder slot - Ukse lukusüdamik		1	30x35		
	Striker for barrel bolt - Hülse für grendelriegel - Gache au sol du targette - Boccola per fermo della porta - Huls voor vergrendelingsschuif - Vasturaud ukse servariivile		2			

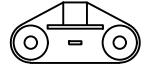
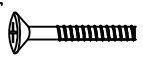
Pos	06.11.2018	Piece list - Stückliste - Liste des pièces - Elementi - Stuklijst - Tükitalabel 835x1882 UL.2.050.ILV.MMd TP+	1/1	Q	P (mm)	L (mm)
		  <p>735x1844 mm</p>				
HS1	Screw for rail - Schraube für schiene - Vis pour rail - Vite per binario - Schroef voor rails - Kruvi siinile		6	4x30		
HS8	Screw for fixing sliding door - Schraube zur Befestigung der schiebetür - Vis de fixation porte coulissante - Vite per fissaggio porta scorrevole - Schroef voor bevestiging schuifdeur - Kruvi lükandukse montaažiks		9	3.5x35		
HS13	Screw for fixing sliding door - Schraube zur Befestigung der schiebetür - Vis de fixation porte coulissante - Vite per fissaggio porta scorrevole - Schroef voor bevestiging schuifdeur - Kruvi lükandukse montaažiks		8	4x60		
HS16	Screw for door jamb - Schraube für Türrahmen - Vis de fixation partie haute avec montants du cadre de porte - Viti x fissaggio montanti porte - Schroef voor deurkozijn - Kruvi ukse lengile		2	5x90		
HS16	Screw for fixing door to the wall - Schraube zur Befestigung für - zarge mit wand - Vis de fixation partie basse dormants de porte au 1er rang de madrier - Viti per fissare la porta alla parete - Schroef voor bevestiging deur naar wand - Kruvi ukse lengi kinnitamiseks seinale		2	5x90		
TS4	Rail - Schiene - Rail - Guida binaria - Rails - Lükandukse juhtsiin		1	28x31	1620	
HS5	Screw for sliding door support plate - Schraube für Zubehör für Türblatt - Vis pour la plaque du support de la porte coulissante - Vite per piastra di supporto porta scorrevole - Schroef voor schuifdeur deurbeslag - Kruvi lükandukse kandeplaadile		8	3.5x40		
HS7	Screw for fixing sliding door - Schraube zur Befestigung der schiebetür - Vis de fixation porte coulissante - Vite per fissaggio porta scorrevole - Schroef voor bevestiging schuifdeur - Kruvi lükandukse montaažiks		4	3.5x25		
TS5	Rail for door - Schiene für Türblatt, unten - Patin de guidage - Guida per porta - Deur rails - Lükandukse alumine juhik		1	4.5x65		
TS6	Sliding door support plate - Zubehör für Türblatt - La plaque du support de porte coulissante - Piastra di supporto per porta scorrevole - Deur toebehoren - Lükandukse kandeplaat		2	3x30		
TS8	Fixator for sliding door - Fixer für schiebetür - Boutee d'arrêt porte coulissante - Fissatore per porta scorrevole - Bevestiging voor schuifdeur - Lükandukse lahtihoiufiksaator		2	3.5x15		
TS11	Roller for sliding door - Laufrad für schiebetür - Ferrure pour porte coulissante - Rullo per porta scorrevole - Wielkatrol voor schuifdeur - Lükandukse vanker		2	3.5x35		
TS12	Bolt for sliding door roller - Bolzen für schiebetür laufrad - Boulon pour roller de porte coulissante - Bullone per rullo porta scorrevole - Schuifdeur bout - Lükandukse vankri ja kandeplaadi ühenduspolt		2	3.5x35		

