

Weser 4
4019194
1/7



22.03.2018

Art. Nr. 4019194

Groundplan - Grundplan - Plan de masse -
Planimetria - Plattegrond - Põhiplaan

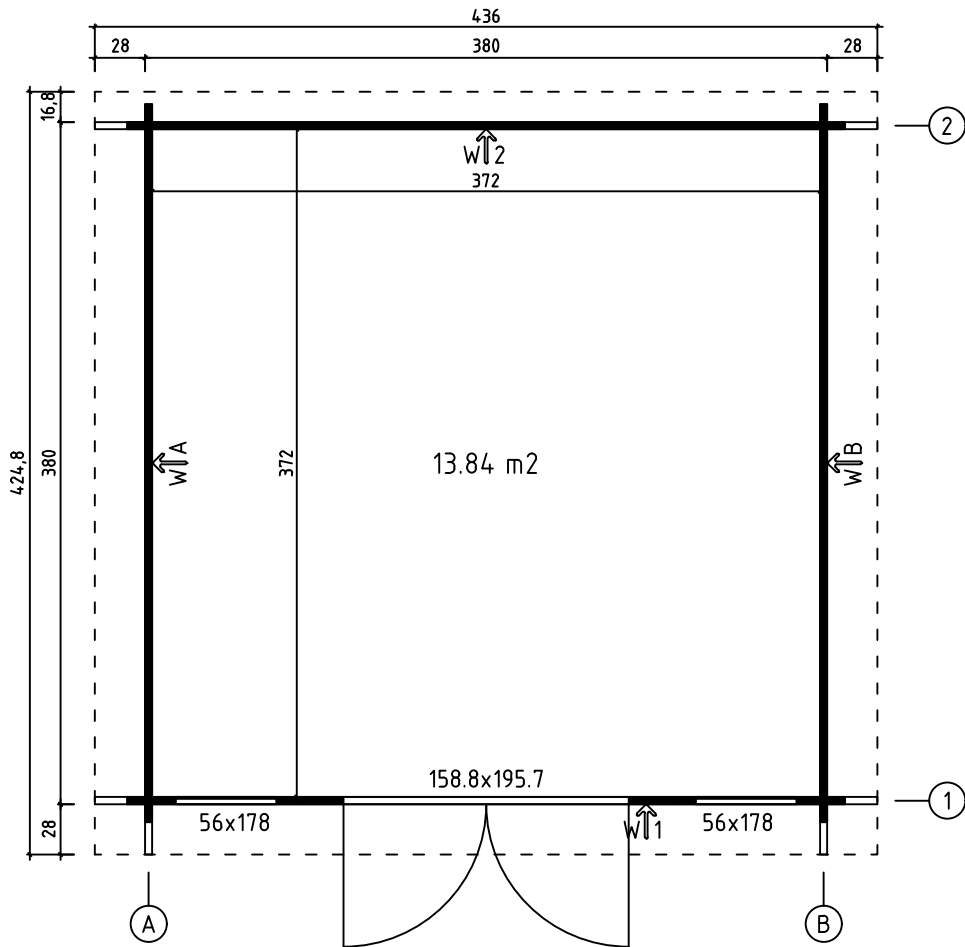

Foundation - Fundament - Fondation - Fondamenta -
Fundering - Immutatud alusraam

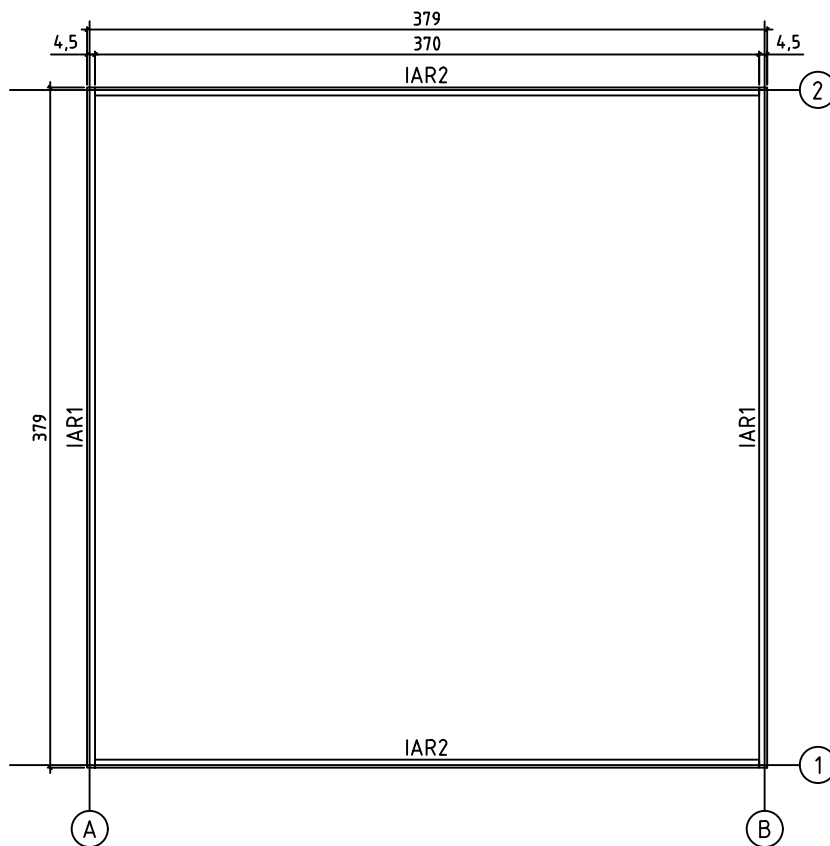

22.03.2018

2/7

Roof plan - Dach-plan - Plan du toit - Piano del tetto - Dak plattegrond - Katuseplaan

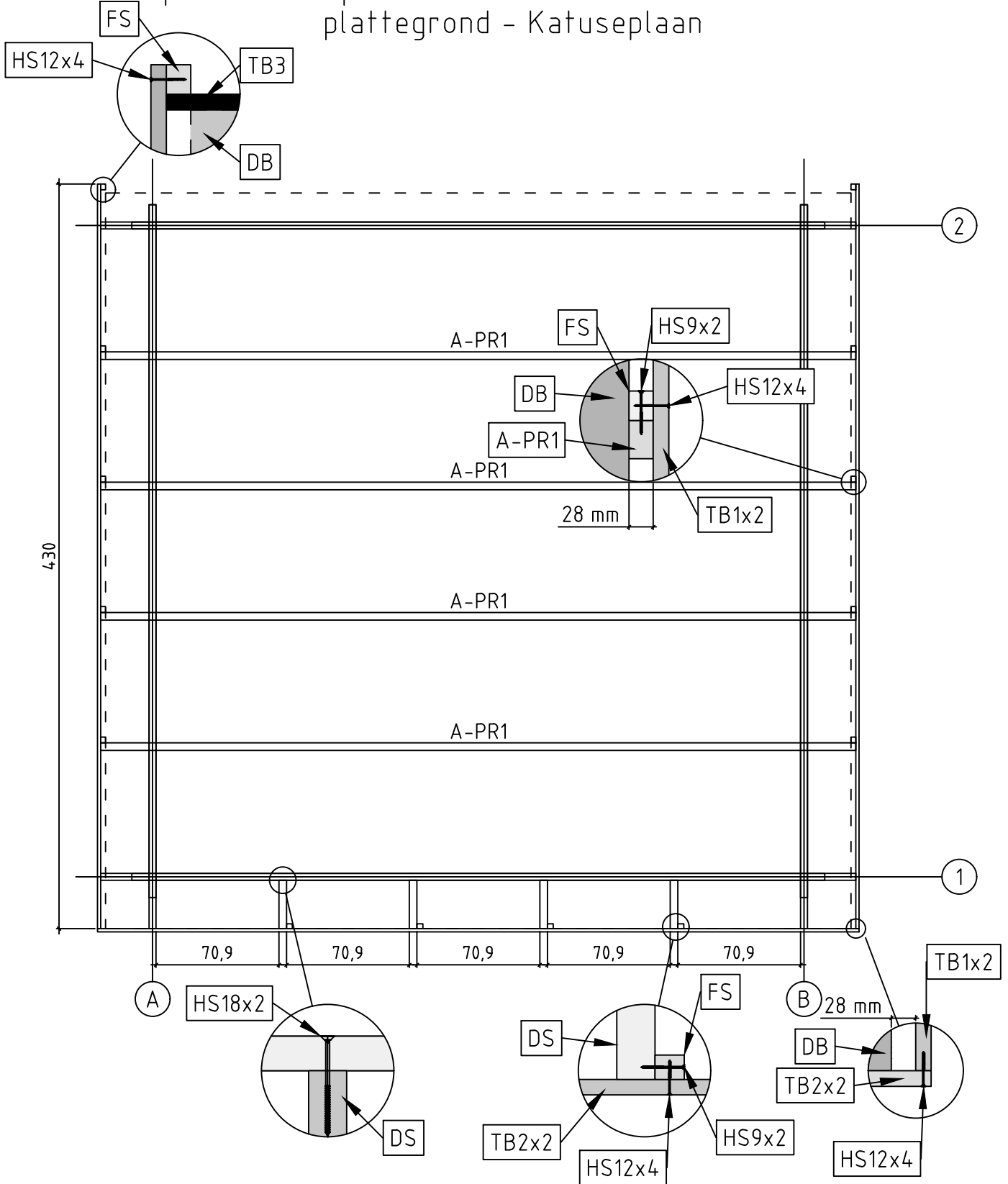



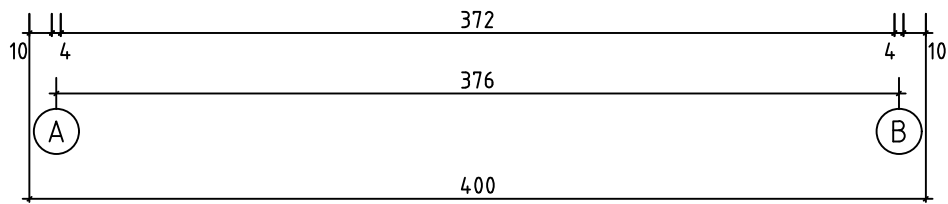
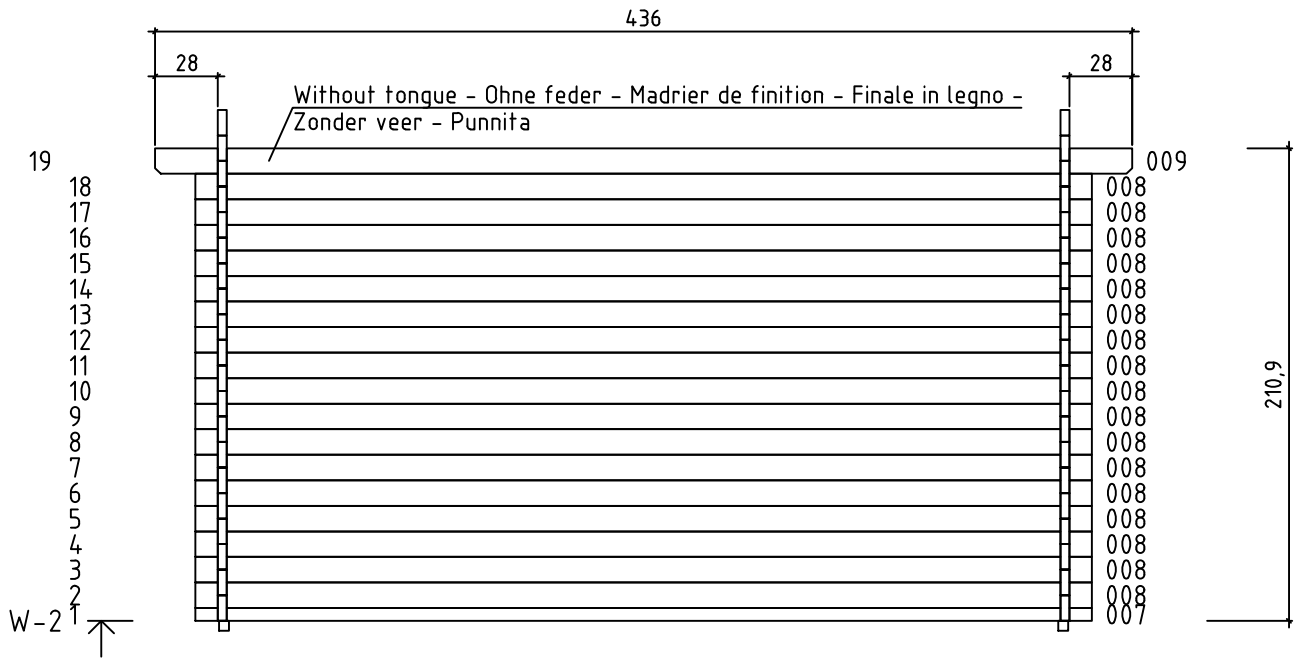
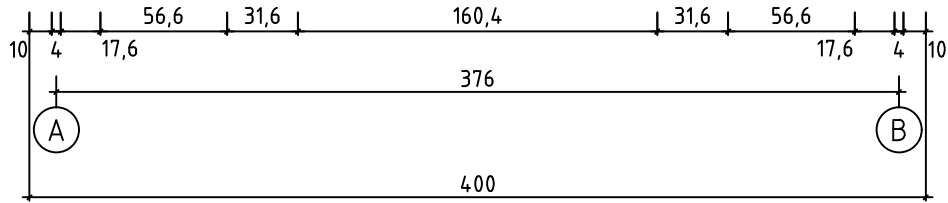
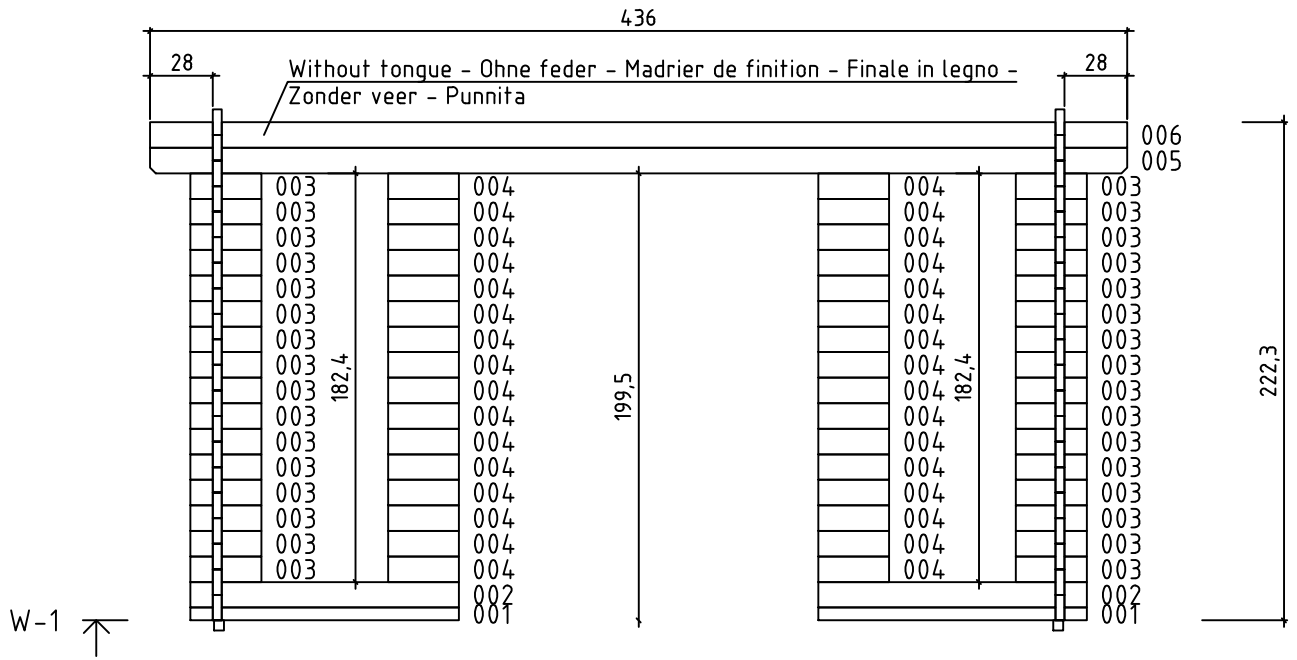



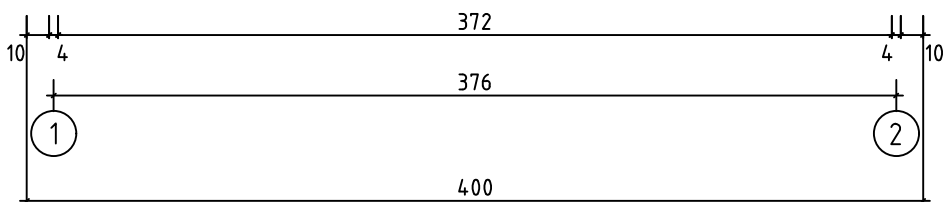
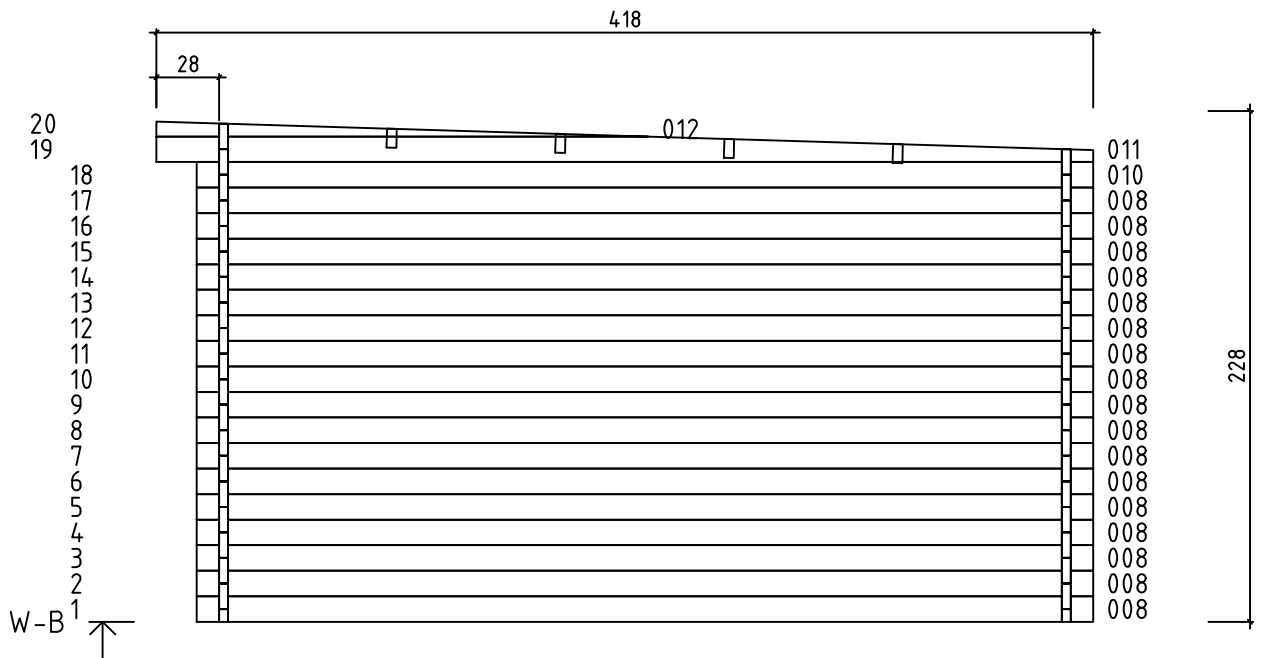
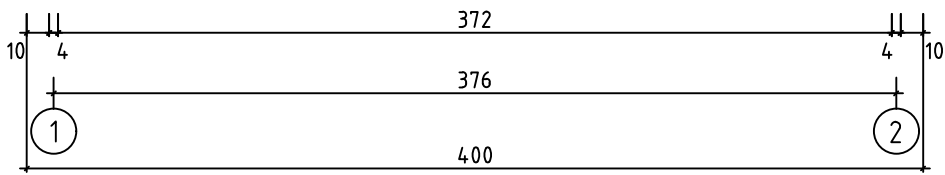
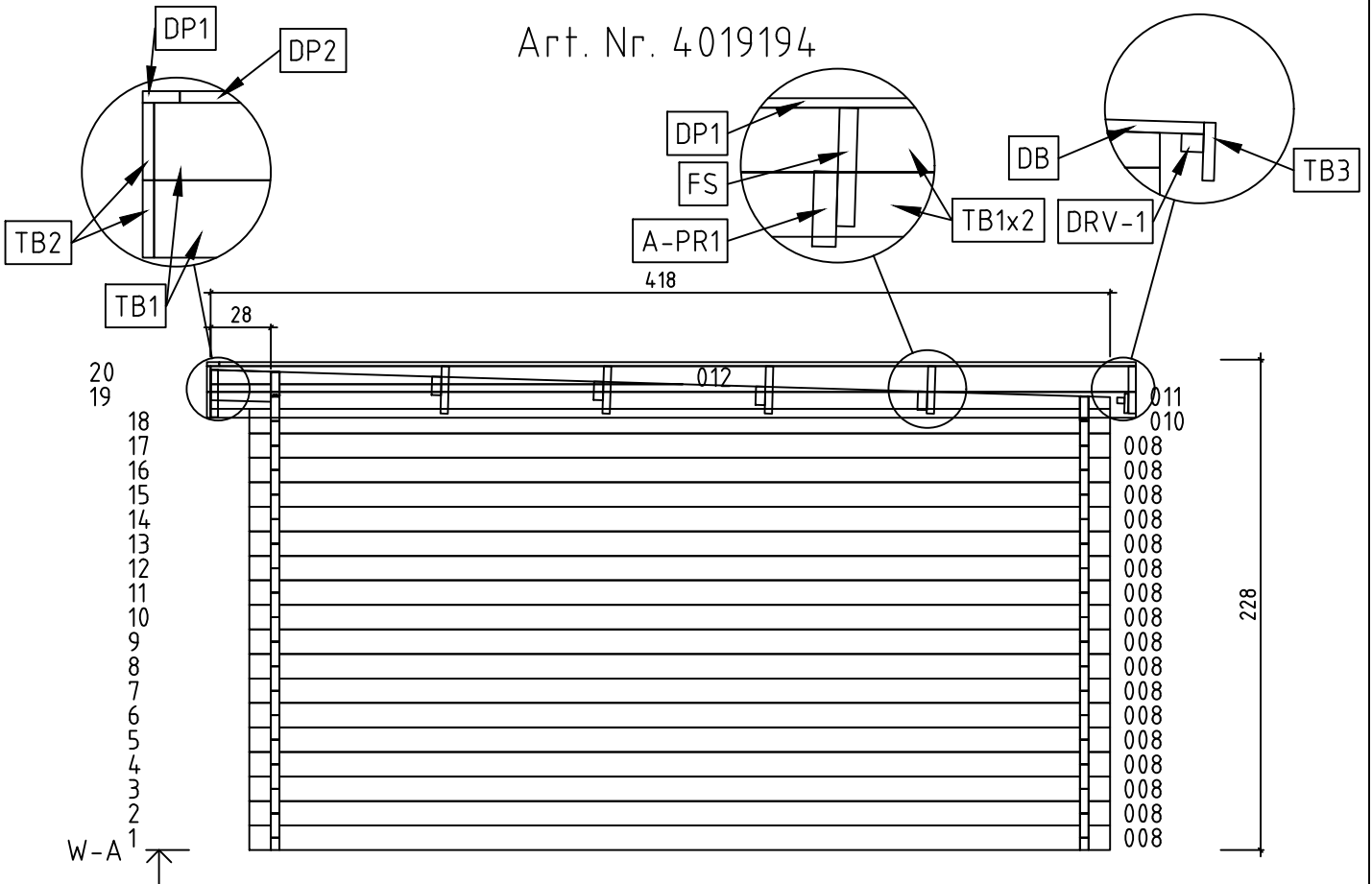

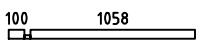
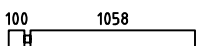

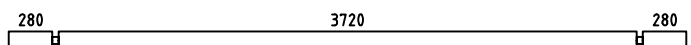
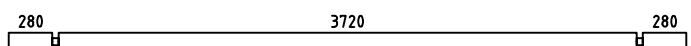
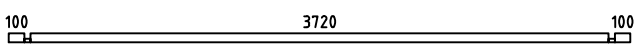
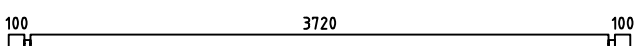
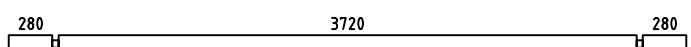
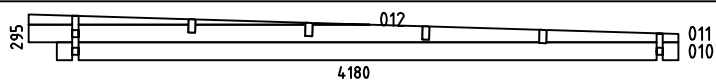
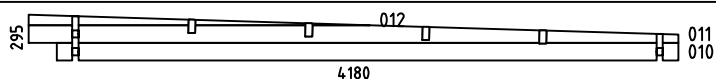

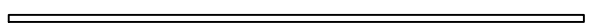
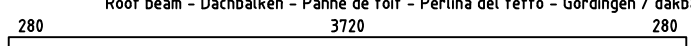
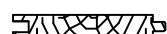
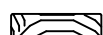
Art. Nr. 4019194

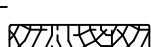
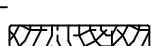
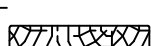

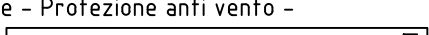
Art. Nr. 4019194



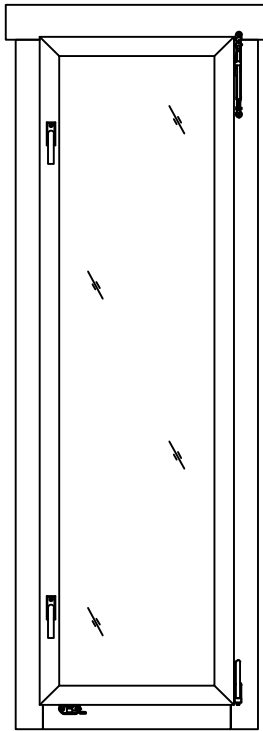
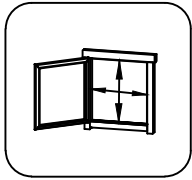



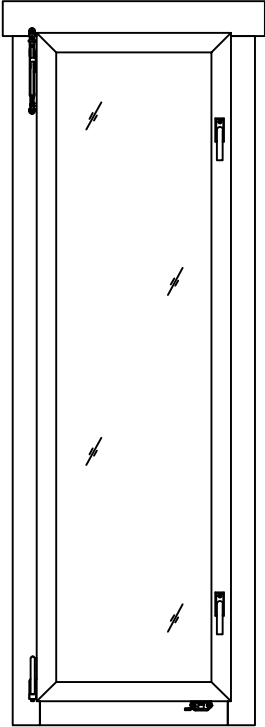
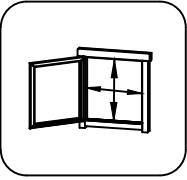

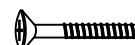
| Pos | 22.03.2018 Piece list - Stückliste - Liste des pièces - Elementi - Stuklijst - Tükitalabel Art. Nr. 4019194 6/7 | Q | P (mm) | L (mm) |
|-------|---|----|-----------|-----------|
| 001 |  | 2 | 40x57 | 1198 |
| 002 |  | 2 | 40x114 | 1198 |
| 003 |  | 32 | 40x114 | 316 |
| 004 |  | 32 | 40x114 | 316 |
| 005 |  | 1 | 40x114 | 4360 |
| 006 |  | 1 | 40x114 | 4360 |
| 007 |  | 1 | 40x57 | 4000 |
| 008 |  | 51 | 40x114 | 4000 |
| 009 |  | 1 | 40x114 | 4360 |
| WA-1 |  | 1 | | |
| WB-1 |  | 1 | | |
| IAR1 | Foundation - Fundament - Fondation - Fondamenta - Fundering - Immutatud alusraam  | 2 | 45x45 | 3790 |
| IAR2 | Foundation - Fundament - Fondation - Fondamenta - Fundering - Immutatud alusraam  | 2 | 45x45 | 3700 |
| A-PR1 | Roof beam - Dachbalken - Panne de toit - Perlina del tetto - Gordingen / dakbalk - Pärilin  | 4 | 44x140 | 4360 |
| DB | Roof boards - Dachbretter - Voliges - Perlina per tetto - Dakhout - Katuselaud  | 48 | 90x18 | 4250 |
| DP1 | Roofing felt fillet - Dachpappenleiste - Baguette de fixation du feutre bitumeux - Asse per fissaggio guaina bituminosa - Afdeklijst asfaltpapier - Katusepapiiliist  | 2 | 18x58 | 4260 |
| DP2 | Roofing felt fillet - Dachpappenleiste - Baguette de fixation du feutre bitumeux - Asse per fissaggio guaina bituminosa - Afdeklijst asfaltpapier - Katusepapiiliist  | 1 | 18x58 | 4396 |
| TB1 | Fascia board - Traufbrett - Bandeau de toit - Finitura lati tetto - Gevellijst - Räästalaud  | 4 | 18x120 | 4300 |
| TB2 | Fascia board - Traufbrett - Bandeau de toit - Finitura lati tetto - Gevellijst - Räästalaud  | 2 | 18x120 | 4396 |
| TB3 | Fascia board - Traufbrett - Bandeau de toit - Finitura lati tetto - Gevellijst - Räästalaud  | 1 | 18x90 | 4360 |
| DRV-1 | Roof edge reinforcement - Dachrandverstärkung - Corniere de renfort de bord de toit - Rinforzo x tetto - Dakrand versterking - Räästatugevdus  | 1 | 28x34 | 4360 |
| KFS-1 | Storm protection - Sturmleiste - Latte anti-tempete - Protezione anti vento - Stormverankering / beveliging - Tormikinnitusliist  | 4 | 22x45 | 2500 |
| FS | Fixing slat for distance spacers - Befestigungsleiste - Renforts planches de rives - Stecca per fissare i distanziatori - Bevestigingslat afstandhouders - Viitulaua kinnitus  | 14 | 28x34 | 220 |

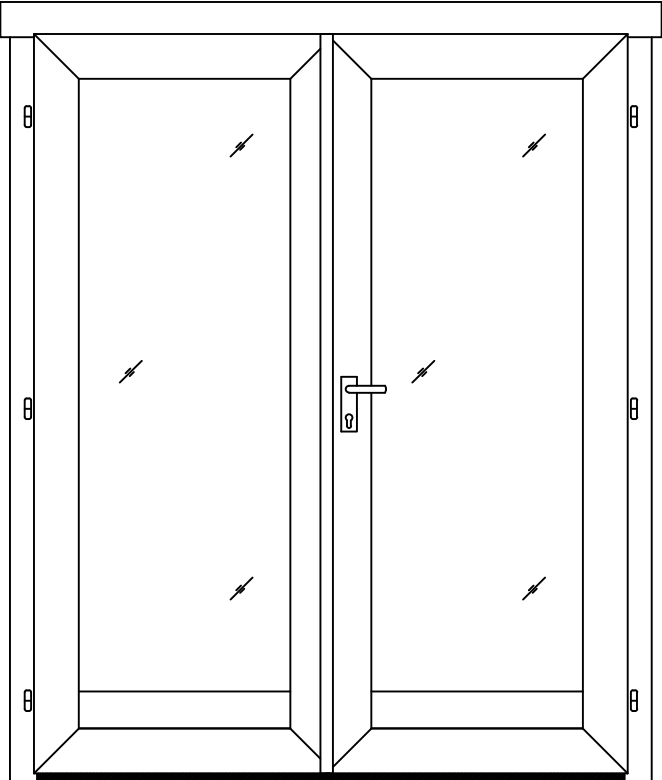
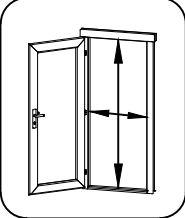
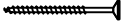
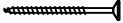
| Pos | 29.01.2016 Piece list - Stückliste - Liste des pièces - Elementi - Stuklijst - Tükítabel 560x1780 AK.1.100.SSP SGC | 1/1 | Q | P (mm) | L (mm) |
|-----|--|---|---|-----------|-----------|
| | <p data-bbox="263 145 1292 179">Glass size - Glasgröße - Taille de la vitre - Misura del vetro - Glas afmeting - Klaasi mõõt: 416x1636 mm</p>   <p data-bbox="1364 336 1500 369">460x1680 mm</p> | | | | |
| FS1 | <p data-bbox="263 2038 1021 2094">Window handle fittings - Fenstergriff - Poignee de fenetre - Maniglia c/ferramenta - Raamhendel -/grendel -/klink - Aknalink</p> | | 2 | | |
| FSP | <p data-bbox="263 2116 1101 2195">Bolt for window handle fittings - Bolzen für fenstergriff beschlag - Vis pour fixation poignee de fenetre - Bullone x apertura manuale finestra - Schroef voor raamhendel - Akna käepideme polt</p> |  | 4 | | |

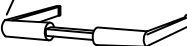
| Pos | 29.01.2016 Piece list - Stückliste - Liste des pièces - Elementi - Stuklijst - Tükitalabel 560x1780 AK.1.100.SSV SGC | 1/1 | Q | P (mm) | L (mm) |
|-----|--|-----|---|-----------|-----------|
| | <p data-bbox="260 145 1289 174">Glass size - Glasgröße - Taille de la vitre - Misura del vetro - Glas afmeting - Klaasi mõõt: 416x1636 mm</p>   <p data-bbox="1364 340 1497 369">460x1680 mm</p> | | | | |
| FS1 | <p data-bbox="260 2038 1021 2094">Window handle fittings - Fenstergriff - Poignee de fenetre - Maniglia c/ferramenta - Raamhendel -/grendel -/klink - Aknalink</p> | | 2 | | |
| FSP | <p data-bbox="260 2116 1101 2195">Bolt for window handle fittings - Bolzen für fenstergriff beschlag - Vis pour fixation poignee de fenetre - Bullone x apertura manuale finestra - Schroef voor raamhendel - Akna käepideme polt</p> | | 4 | | |

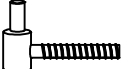

| Pos | 27.03.2013 | Piece list - Stückliste - Liste des pièces - Elementi - Stuklijst - Tükitalabel 1588x1957 TUK.1.100.SVP.MM SGC | 1/1 | Q | P (mm) | L (mm) |
|------|---|--|-----|--------|-----------|-----------|
| | | <p>Glass size - Glasgröße - Taille de la vitre - Misura del vetro - Glas afmeting - Klaasi mõõt: 561x1593 mm</p>   <p>1488x1875 mm</p> | | | | |
| HS4 | Screw for door fillet - Schraube zur befestigung türleiste - Vis pour fixation baguette d'arret de porte - Viti per massellino della porta - Schroef voor deurlijst - Krugi ukse kokkuvaltssiliistule |  | 5 | 3x30 | | |
| HS16 | Screw for door jamb - Schraube für türrahmen - Vis de fixation partie haute avec montants du cadre de porte - Viti x fissaggio montanti porte - Schroef voor deurkozijn - Krugi ukse lengile |  | 4 | 5x90 | | |
| HS25 | Screw for doorstep - Schrauben für swelle - Vis pour fixation barre de seuil - Vite per soglia della porta - Schroef voor deurdorpel - Krugi lävepakule |  | 3 | 4.5x65 | | |
| TL4 | Door handle fittings - Türgriff - Poignee de porte - Maniglie - Deurhendel / klink - Ukse käepide |  | 1 | | | |
| TL5 | Set of door lock covers - Schlossblenden - Set de garnitures de porte - Copertura serrature - Slot sluitplaat set - Ukse lukuplaat |  | 1 | | | |
| | Cylinder lock - Zylinderschloss - Barillet de porte - Serratura - Cylinder slot - Ukse lukusüdamik |  | 1 | 30x35 | | |
| | Male bolt hinge for door - Türband - Partie male de paumelle de porte - Cerniera anube x porta - Scharnier bout - Ukse polthing isane |  | 6 | | | |
| | Striker for barrel bolt - Hülse für grendelriegel - Gache au sol du targette - Boccola per fermo della porta - Huls voor vergrendelingsschuif - Vasturaud ukse servariivile |  | 2 | | | |