

Bespoke Tahiti 70
Art. Nr.250716.1KL

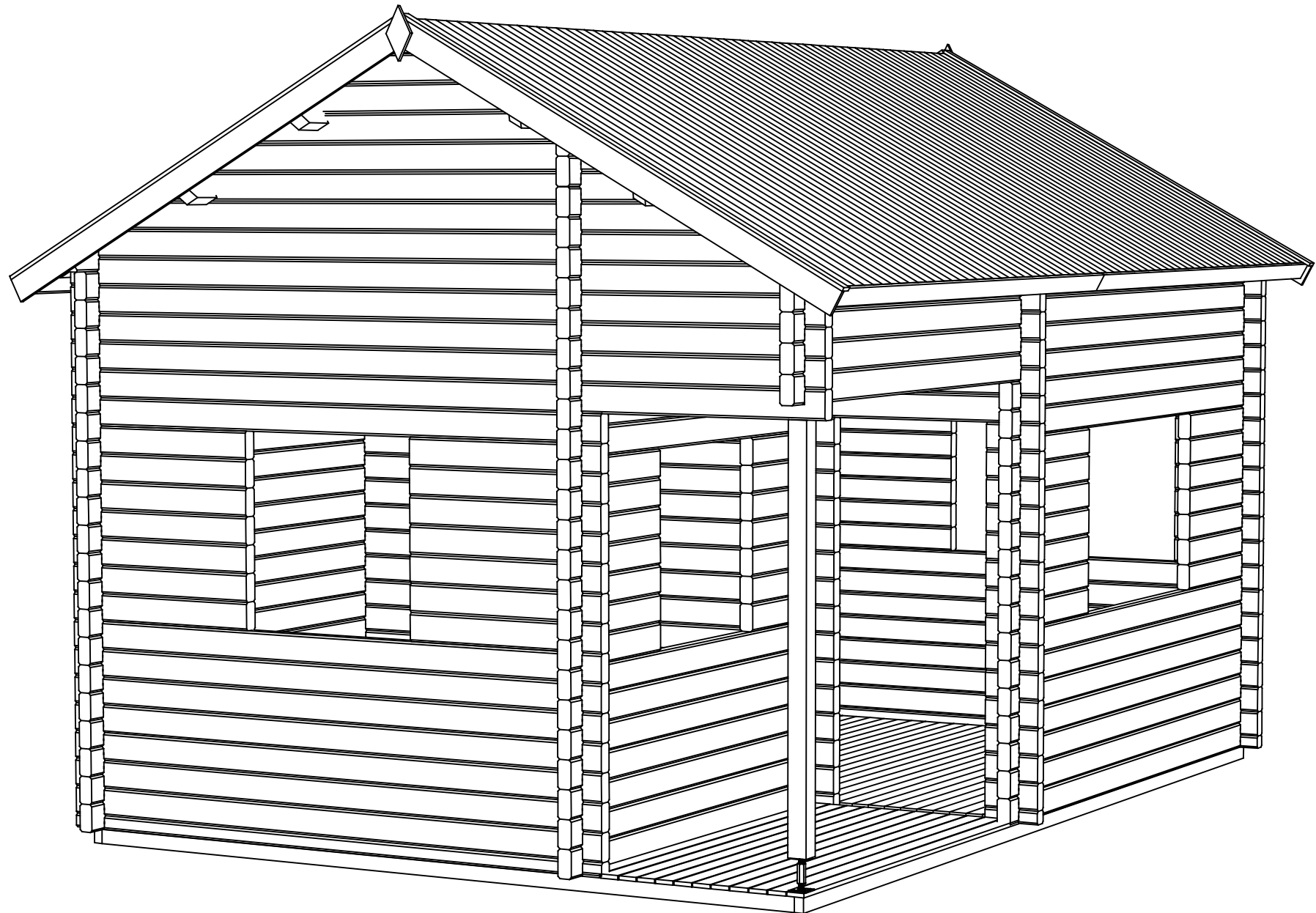

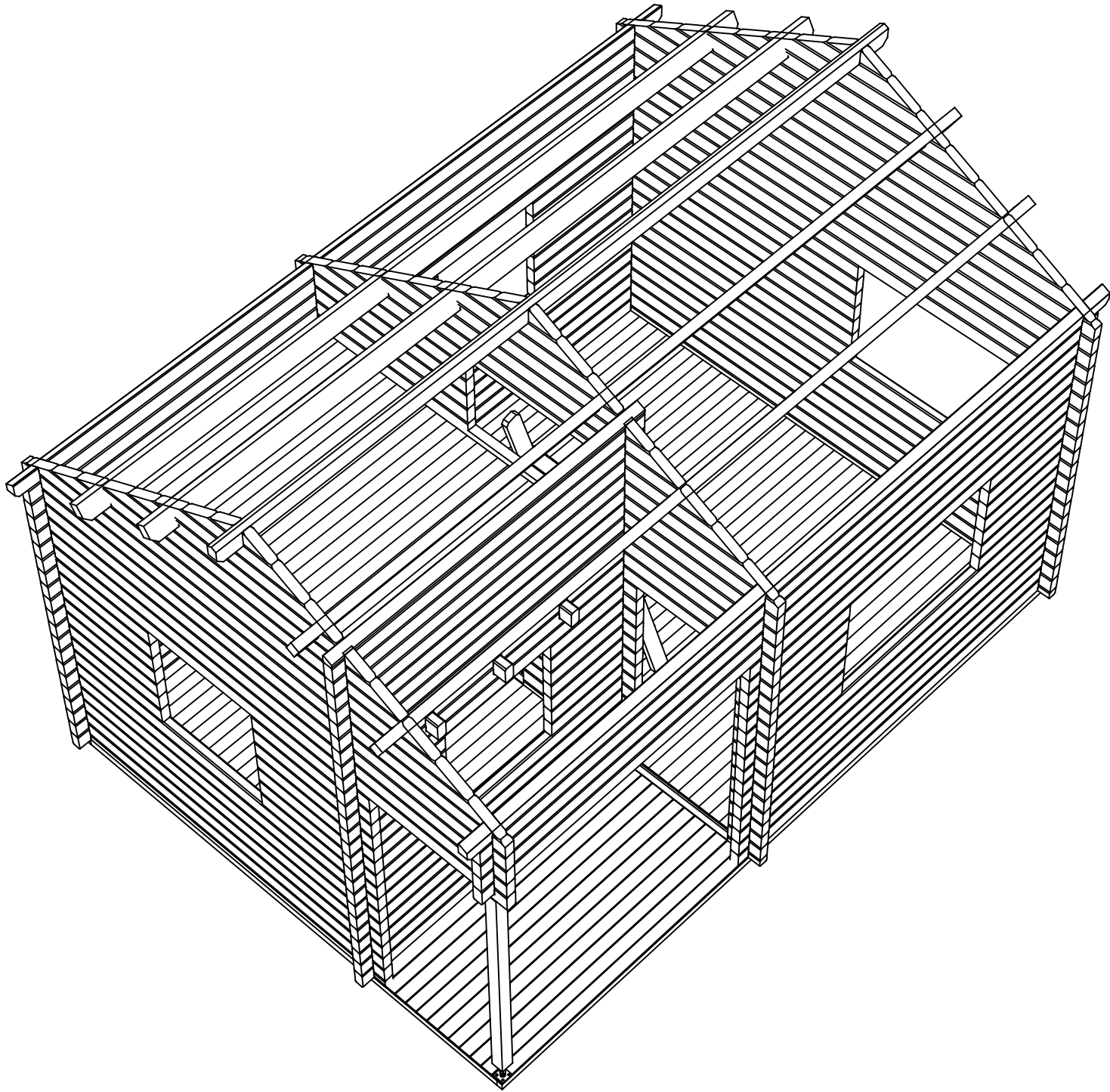

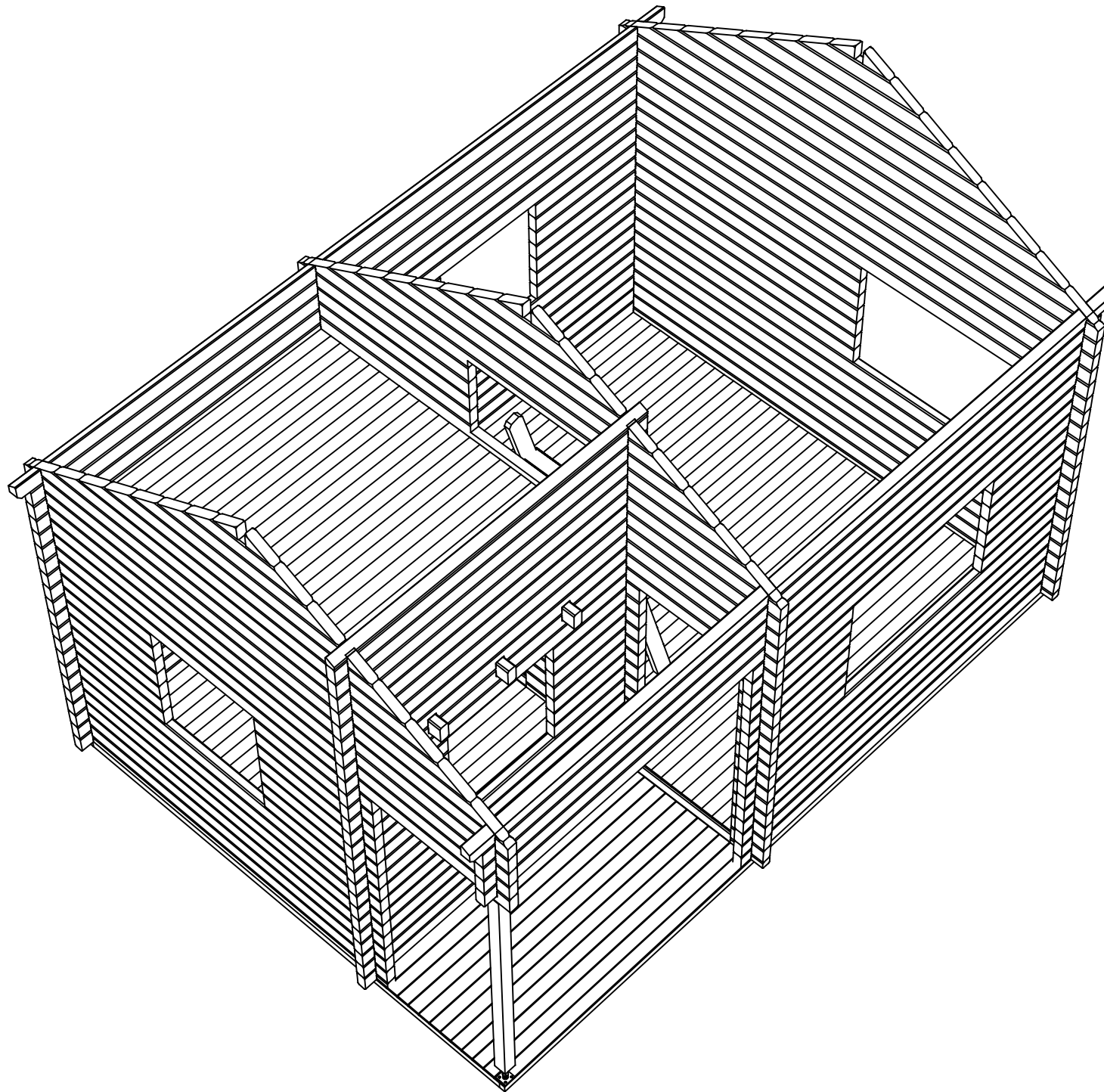

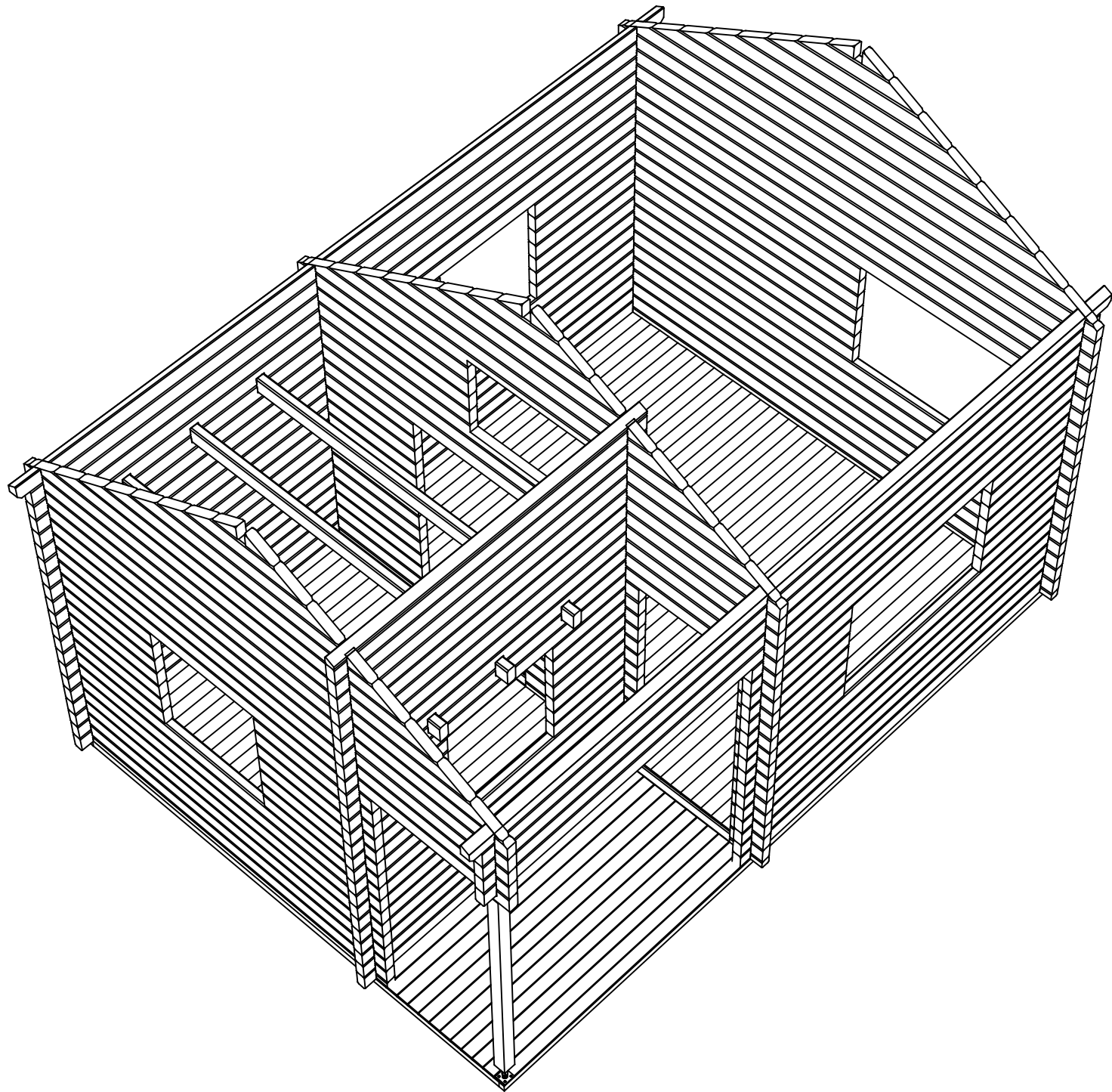

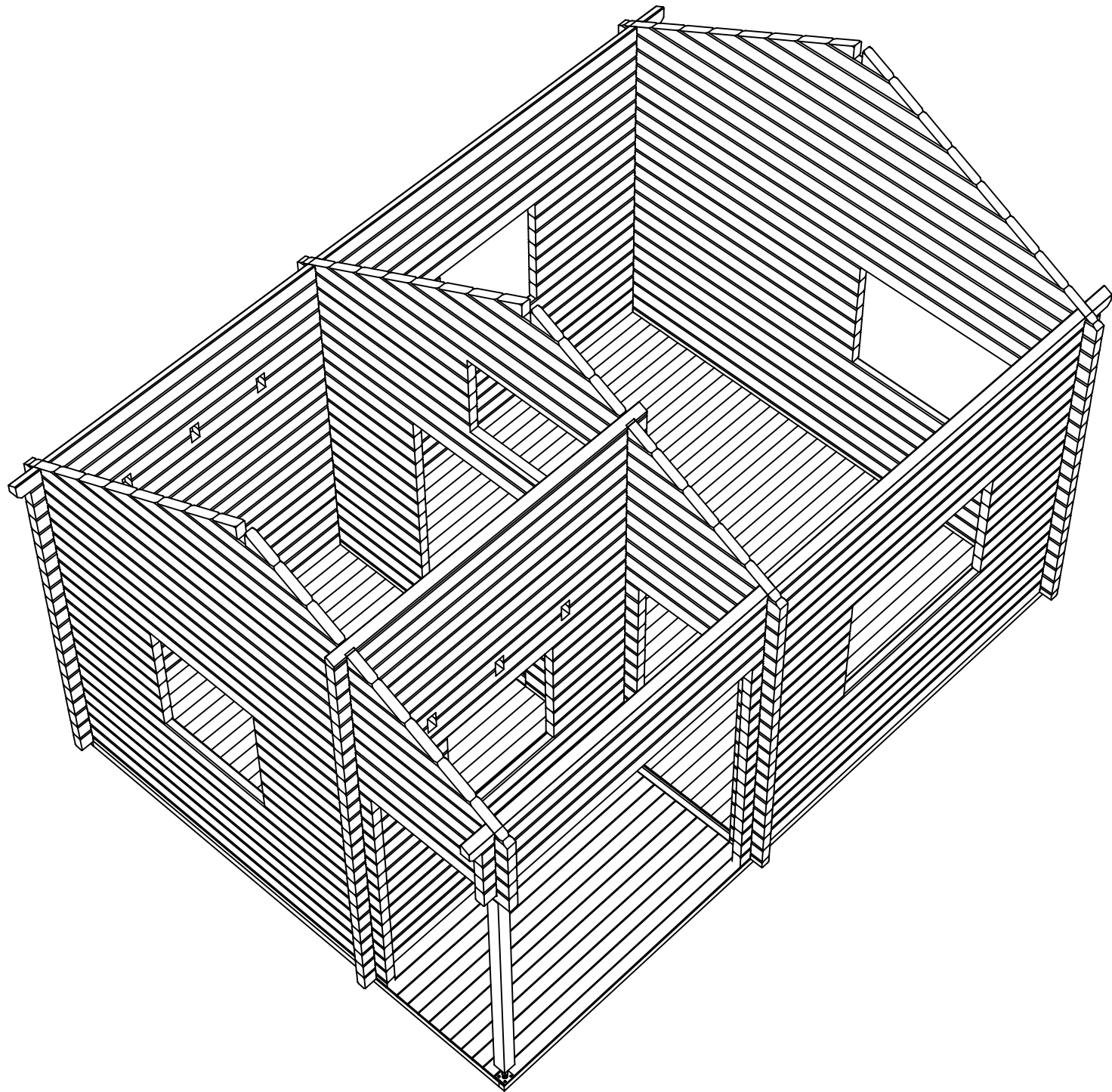

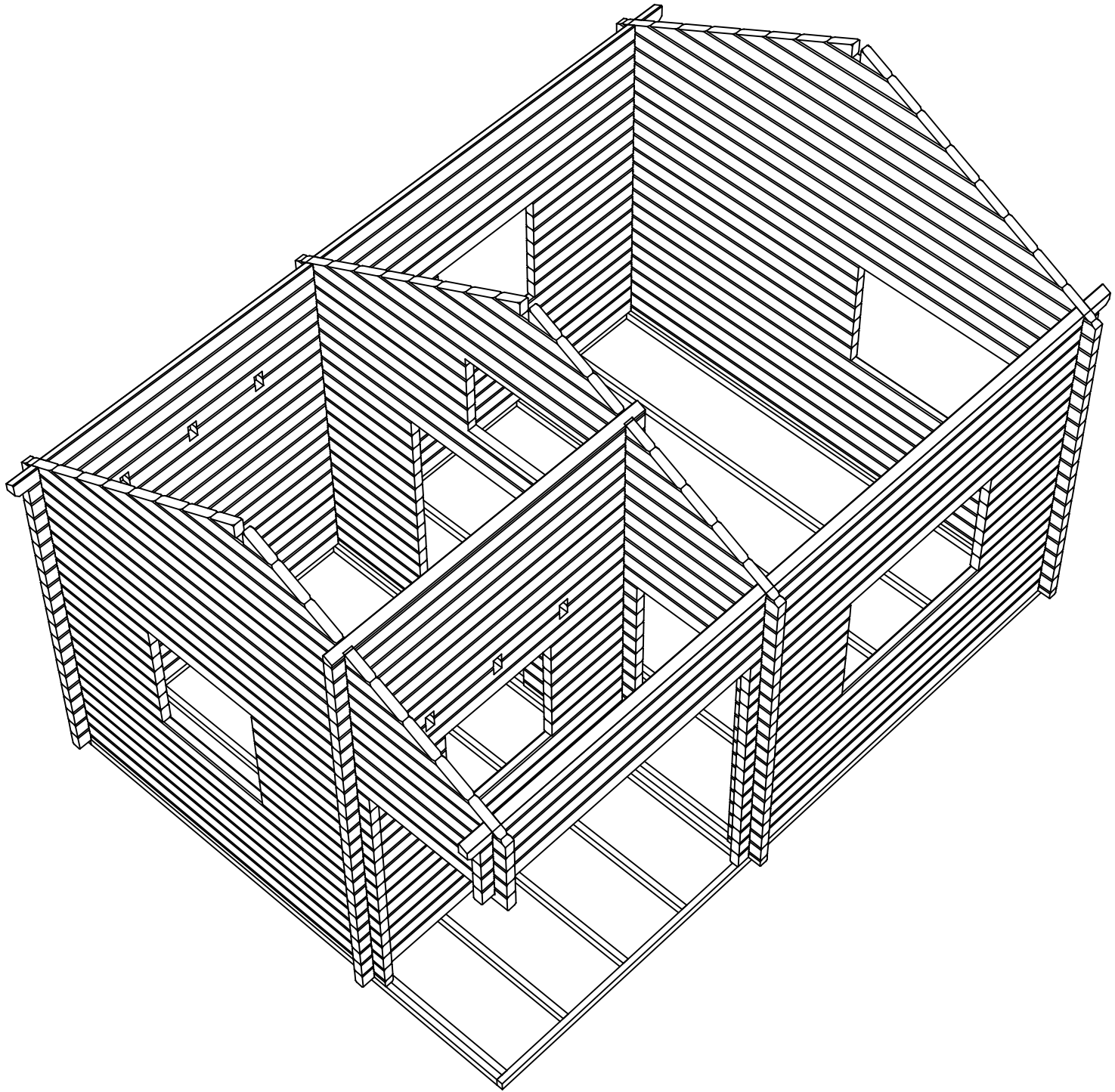

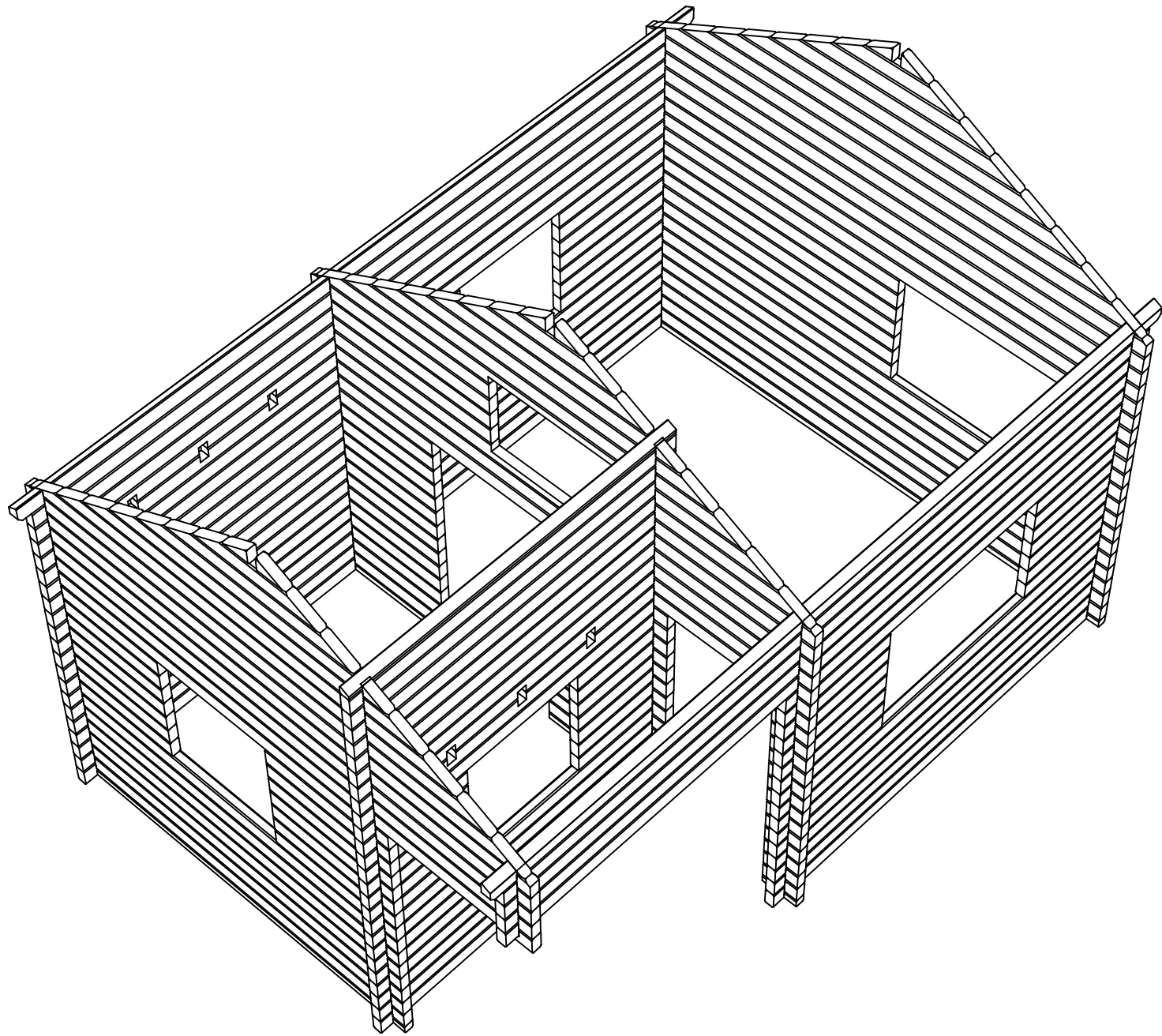

250716.1KL - Bespoke Tahiti 70
GROUNDPLAN

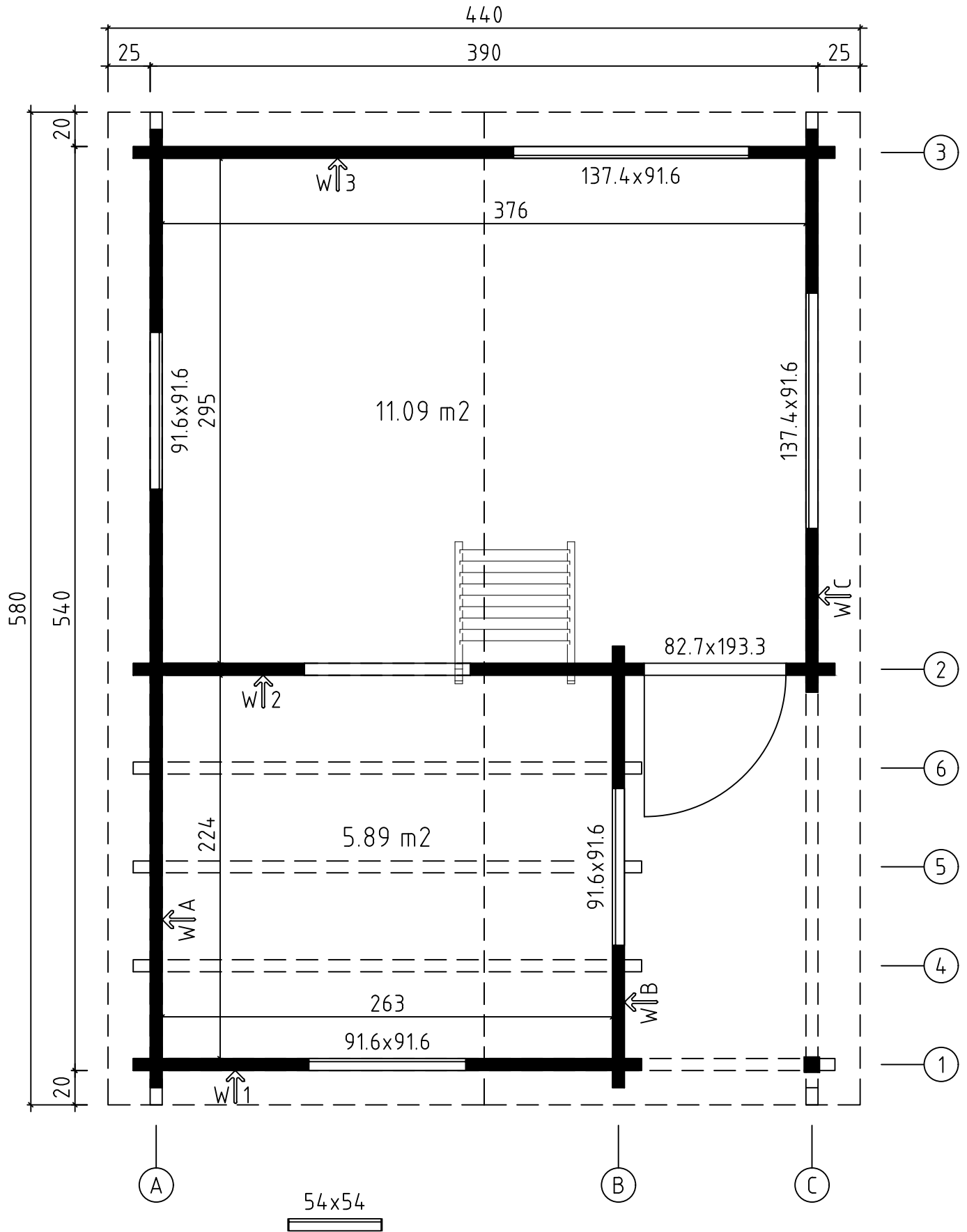

250716.1KL - Bespoke Tahiti 70
GROUNDPLAN

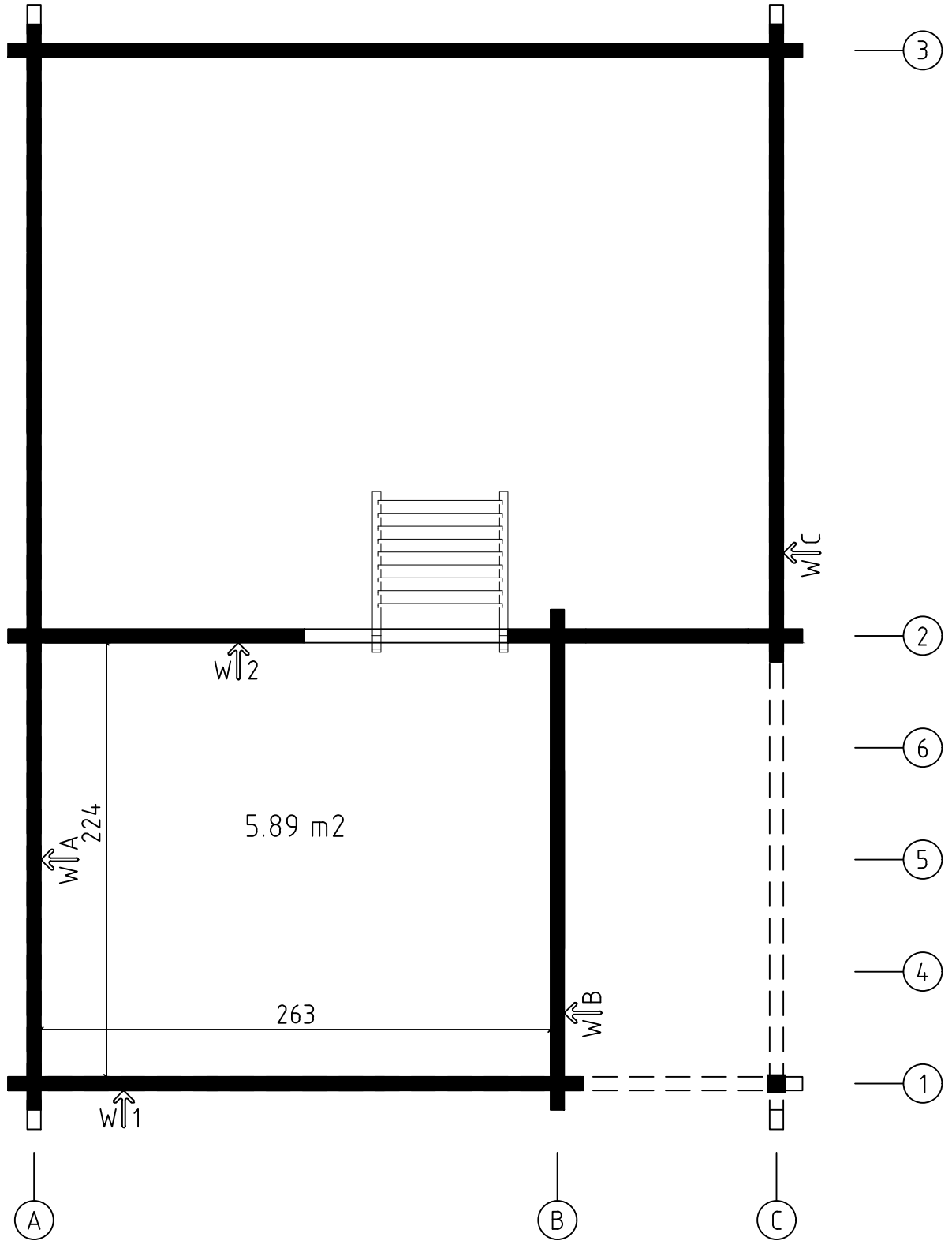

250716.1KL - Bespoke Tahiti 70
FOUNDATION

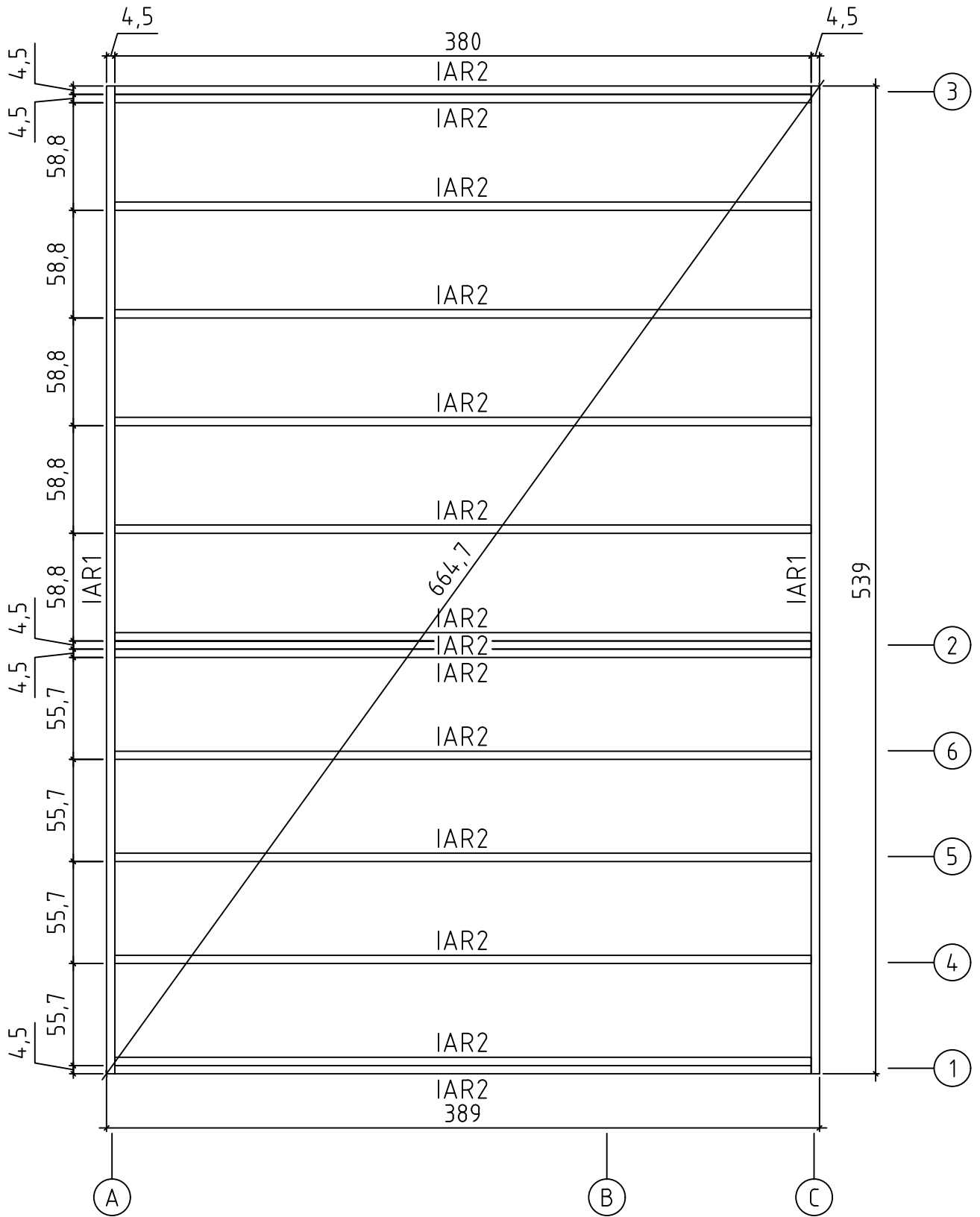

250716.1KL - Bespoke Tahiti 70

FLOOR BOARD
TERRACE BOARD

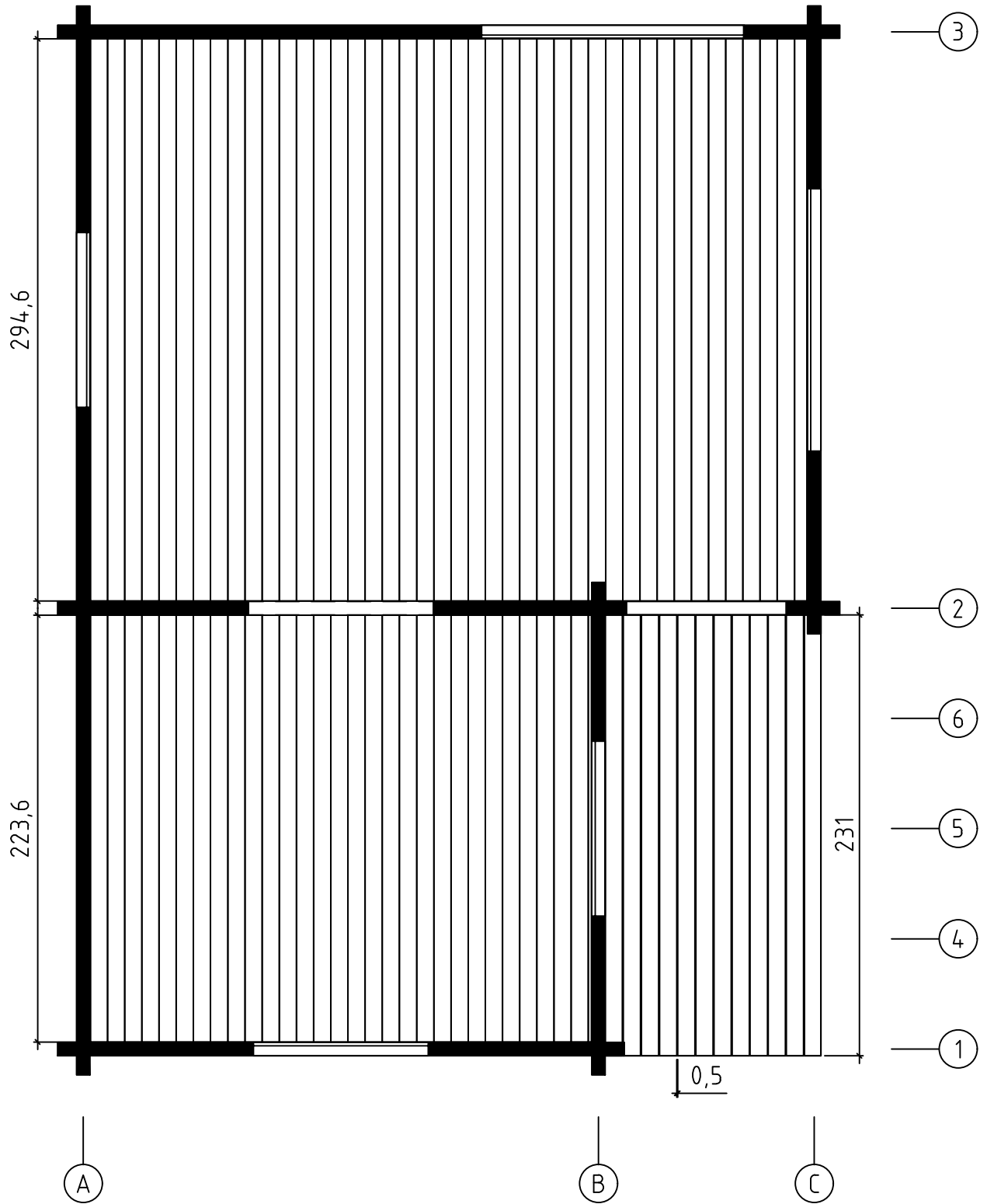

250716.1KL - Bespoke Tahiti 70
FLOOR BOARD

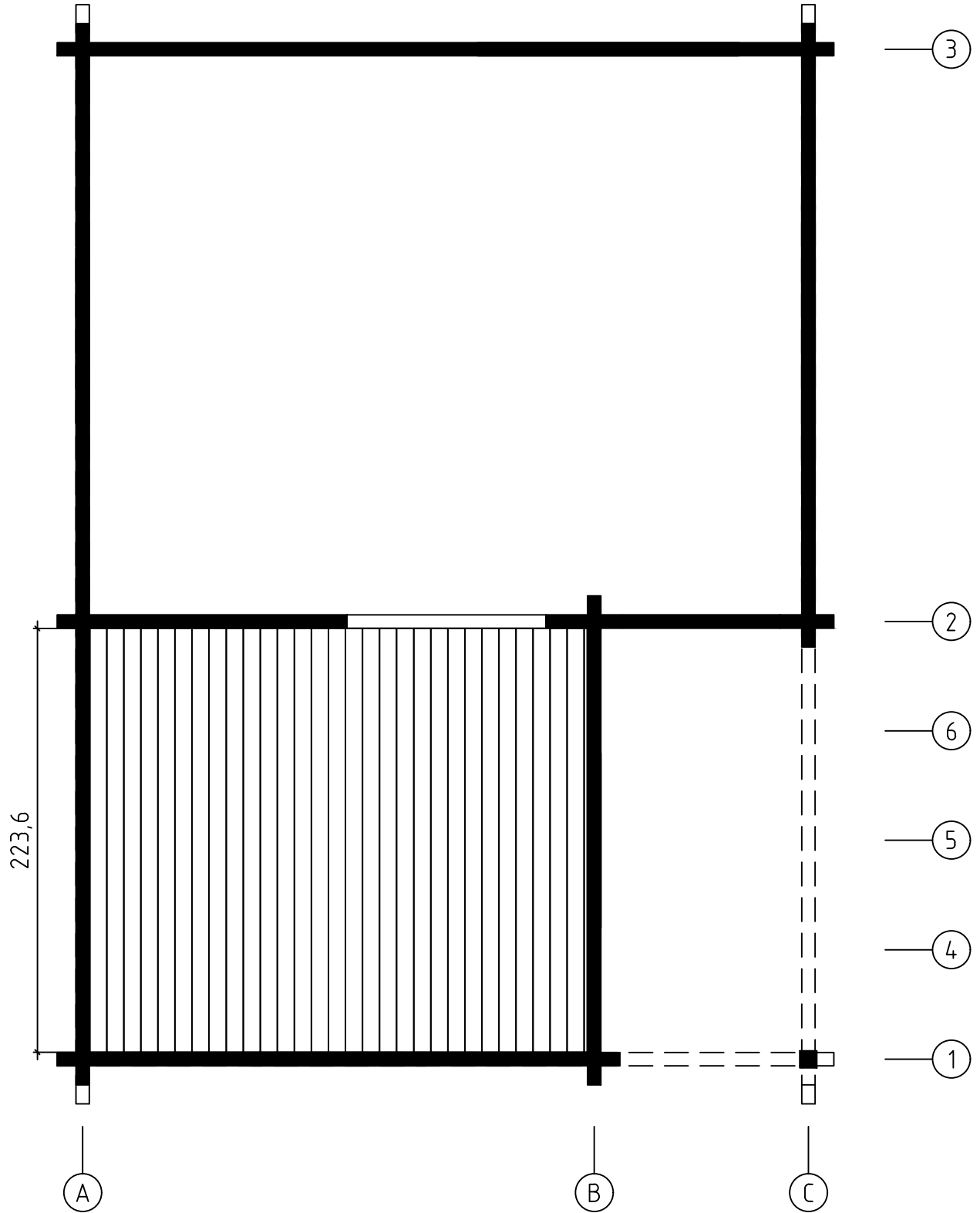

250716.1KL - Bespoke Tahiti 70

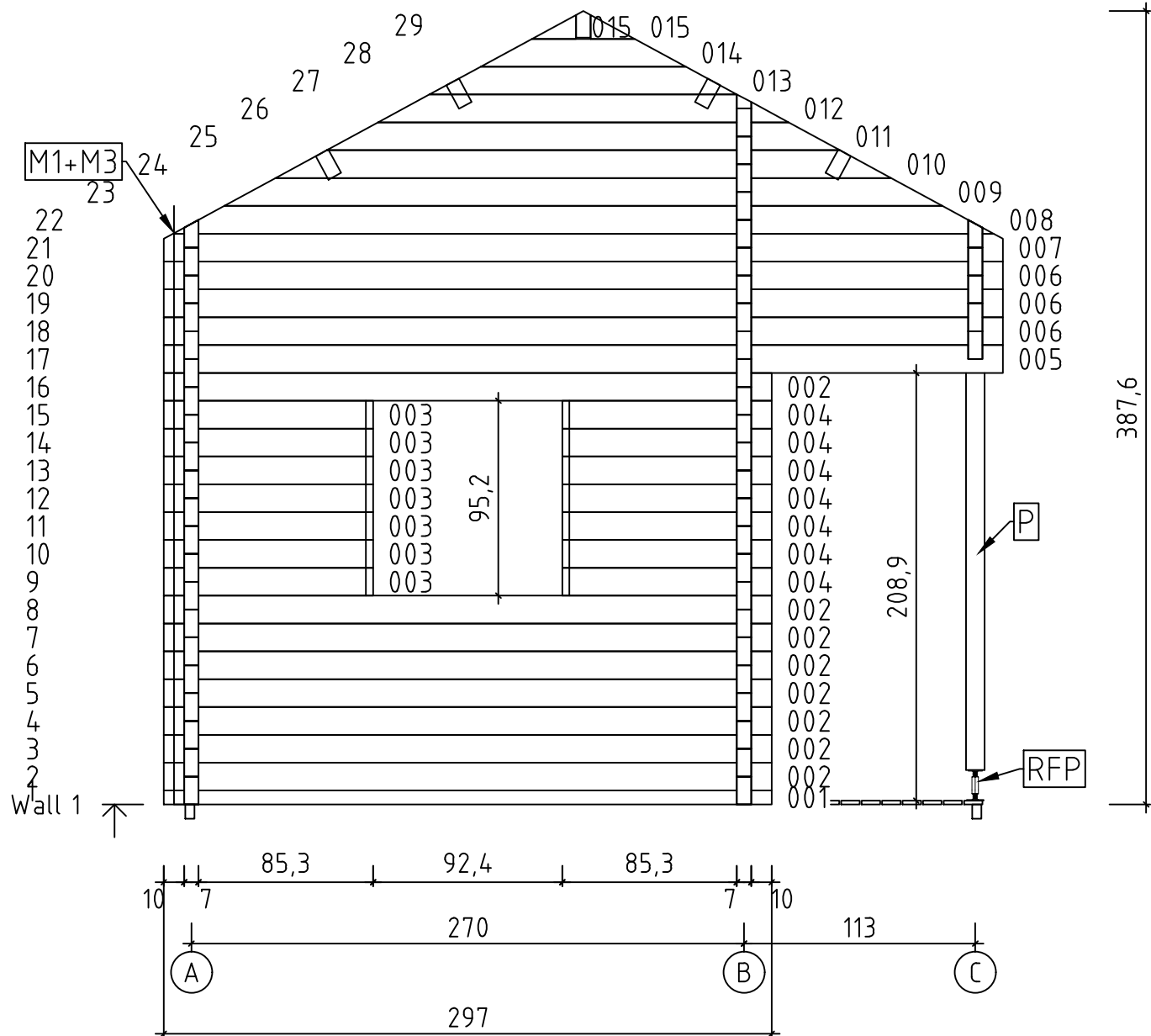

250716.1KL - Bespoke Tahiti 70

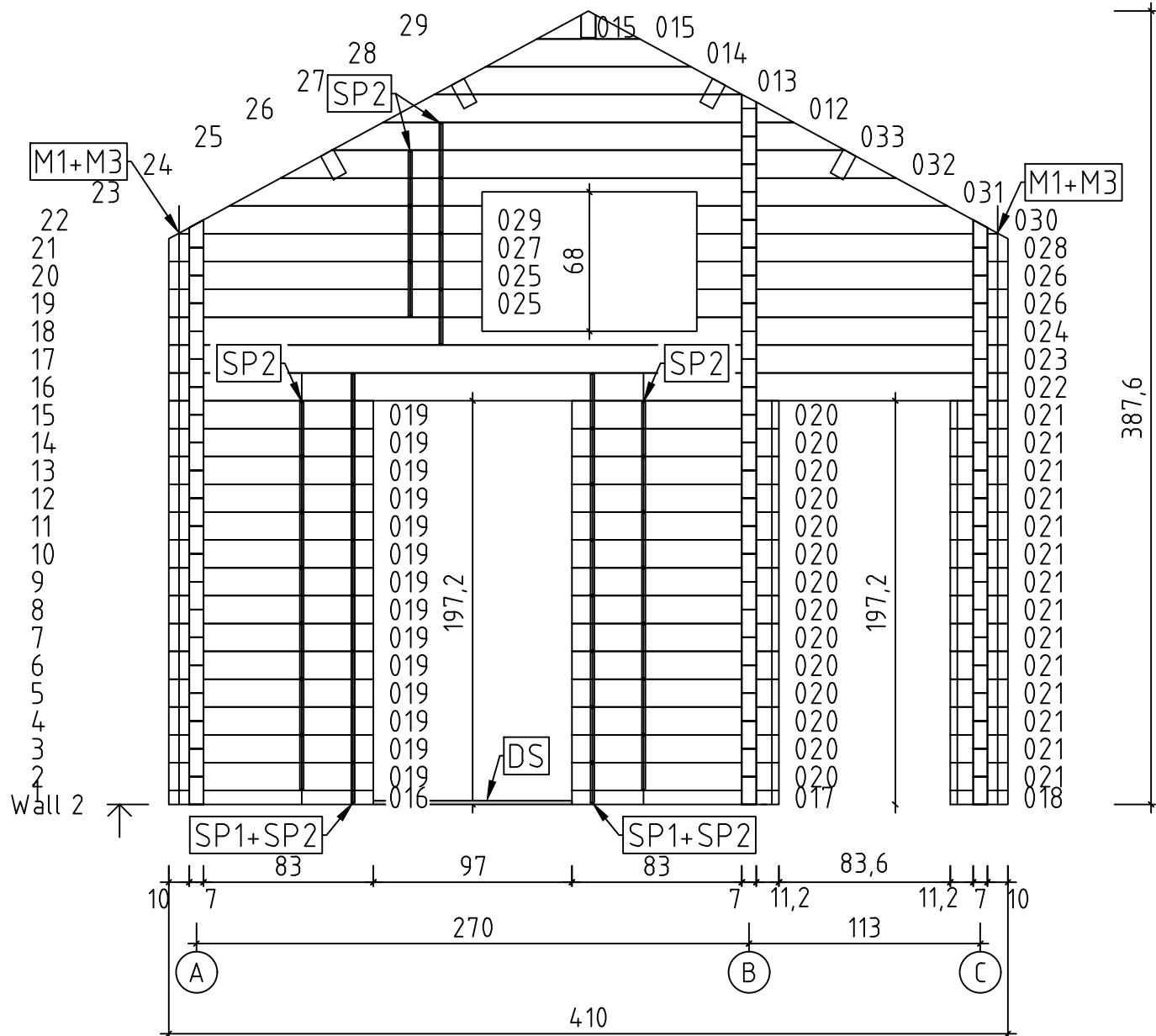

250716.1KL - Bespoke Tahiti 70

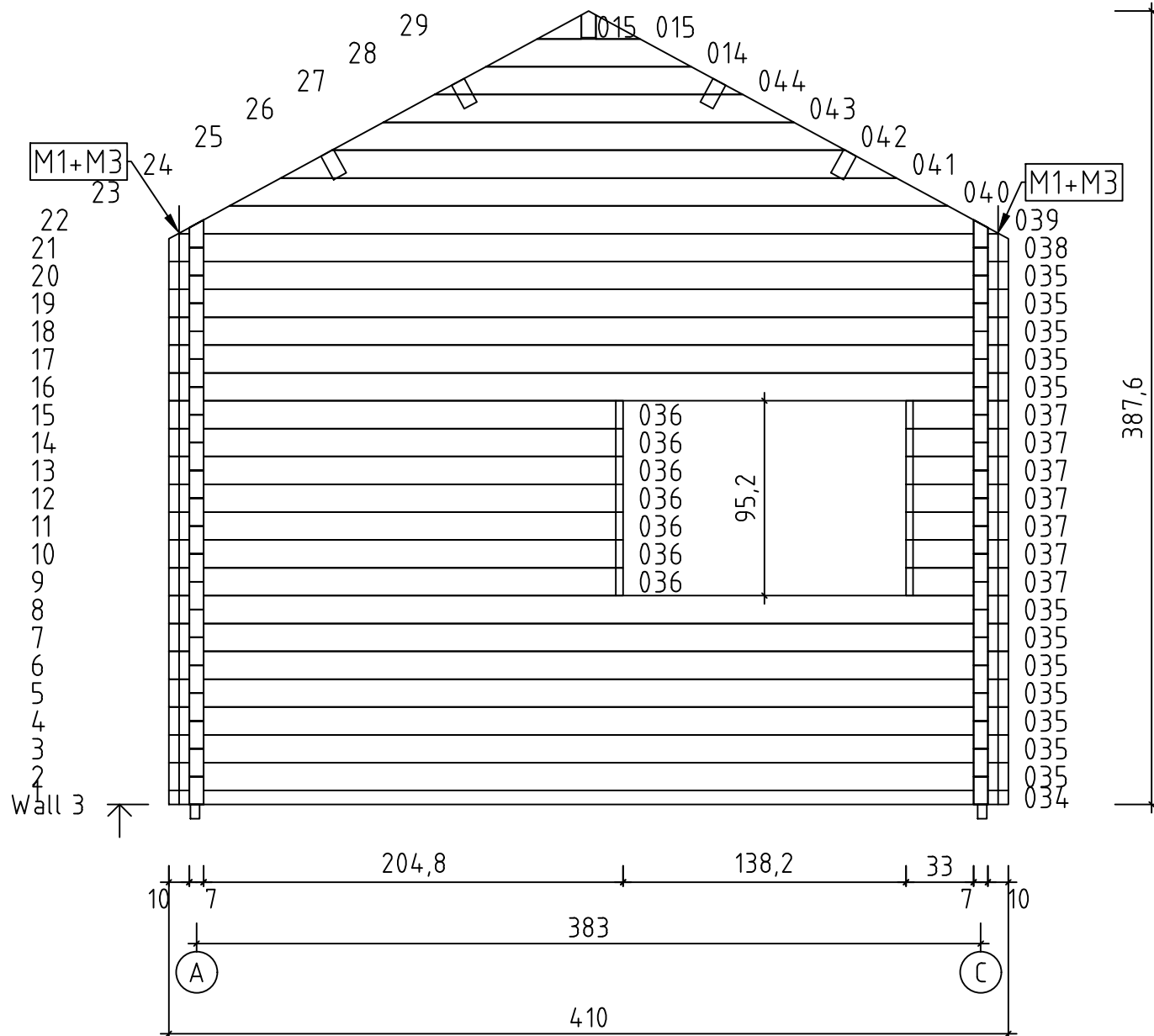

250716.1KL - Bespoke Tahiti 70

580

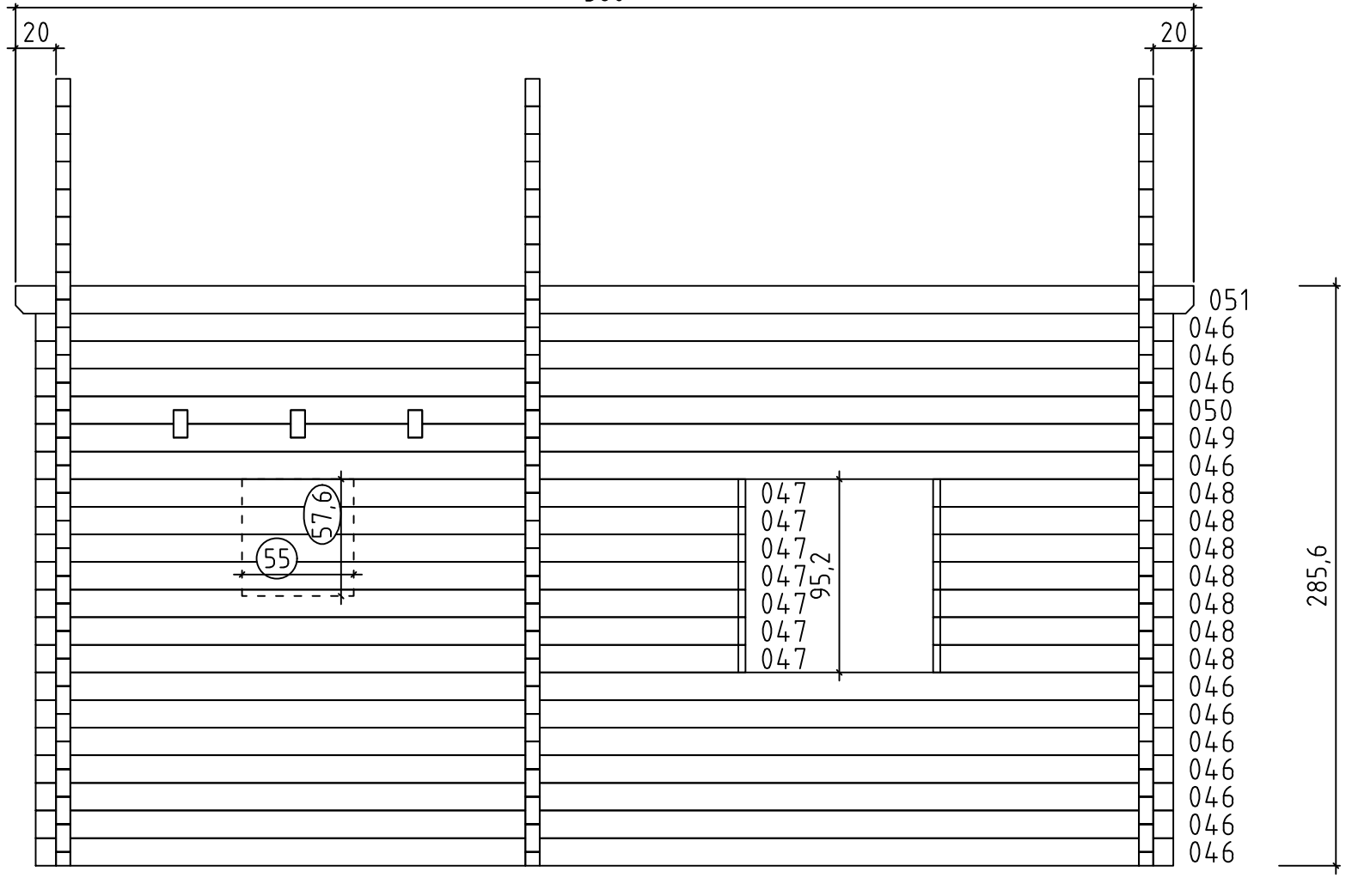

A SINGLE WINDOW (540x540 MM) HAS BEEN DELIVERED TOGETHER WITH THE BUILDING. YOU CAN CHOOSE THE LOCATION FOR THE WINDOW BY YOURSELF BY CUTTING THE WALL LOGS AS SHOWN IN THE PICTURE (SEE THE DOTTED LINE)

Wall A ↑

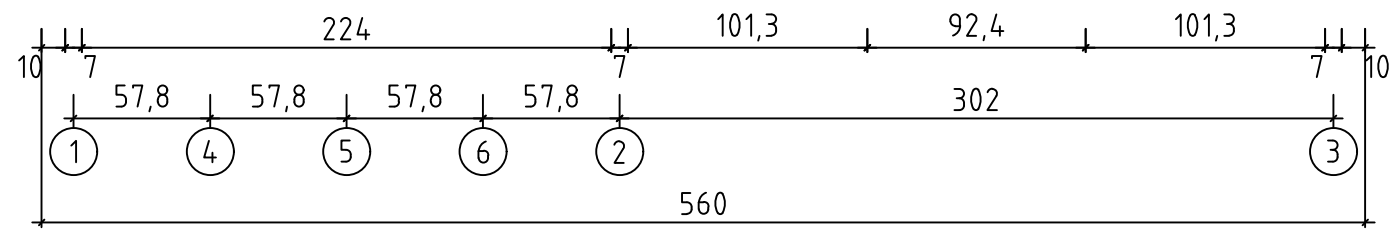

285,6

051
046
046
046
050
049
046
048
048
048
048
048
048
046
046
046
046
046
046

047
047
047
047
047
047
047

95,2

224

101,3

92,4

101,3

10

7

57,8

57,8

57,8

57,8

7

302

7

10

560

1

4

5

6

2

3

250716.1KL - Bespoke Tahiti 70

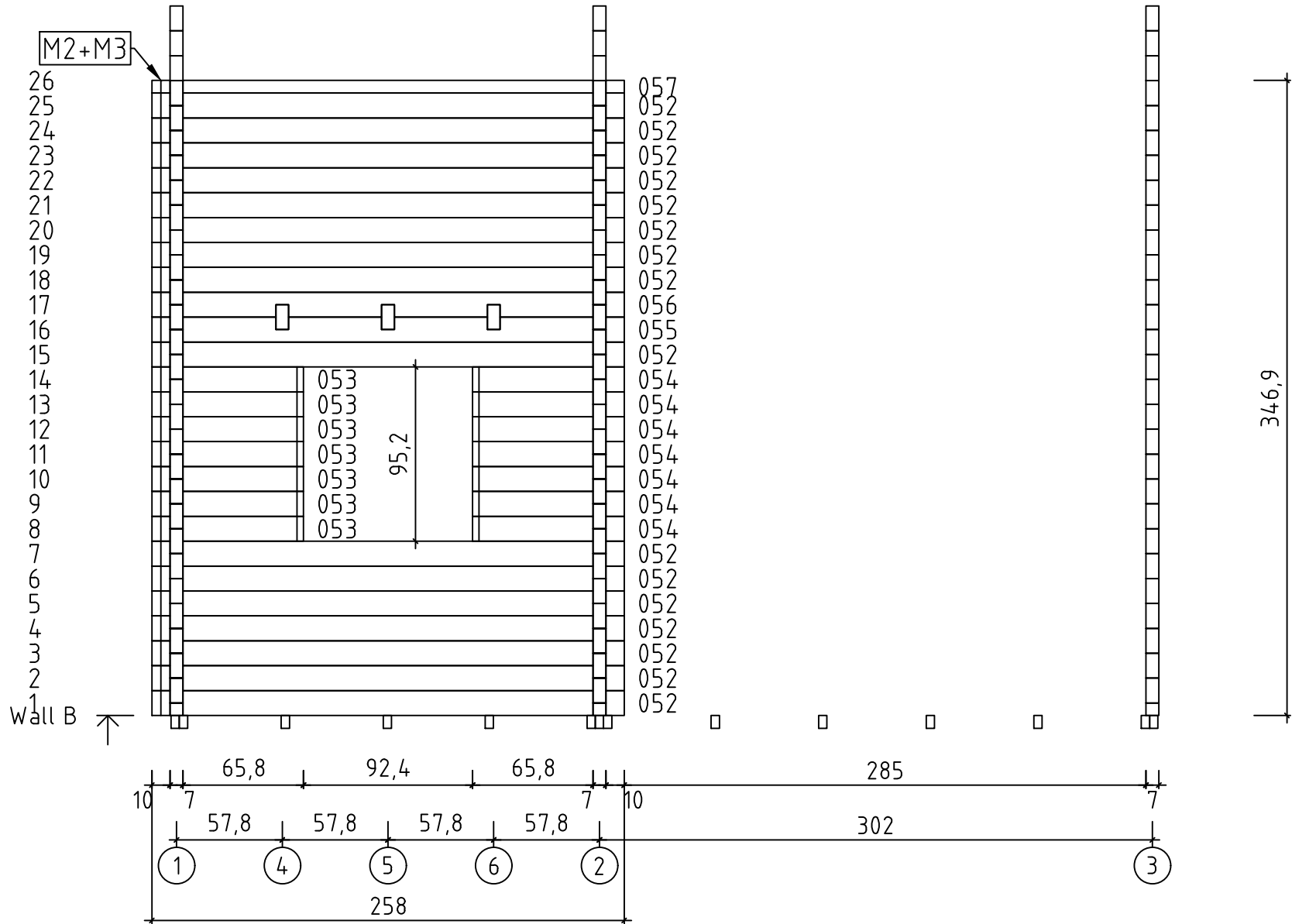



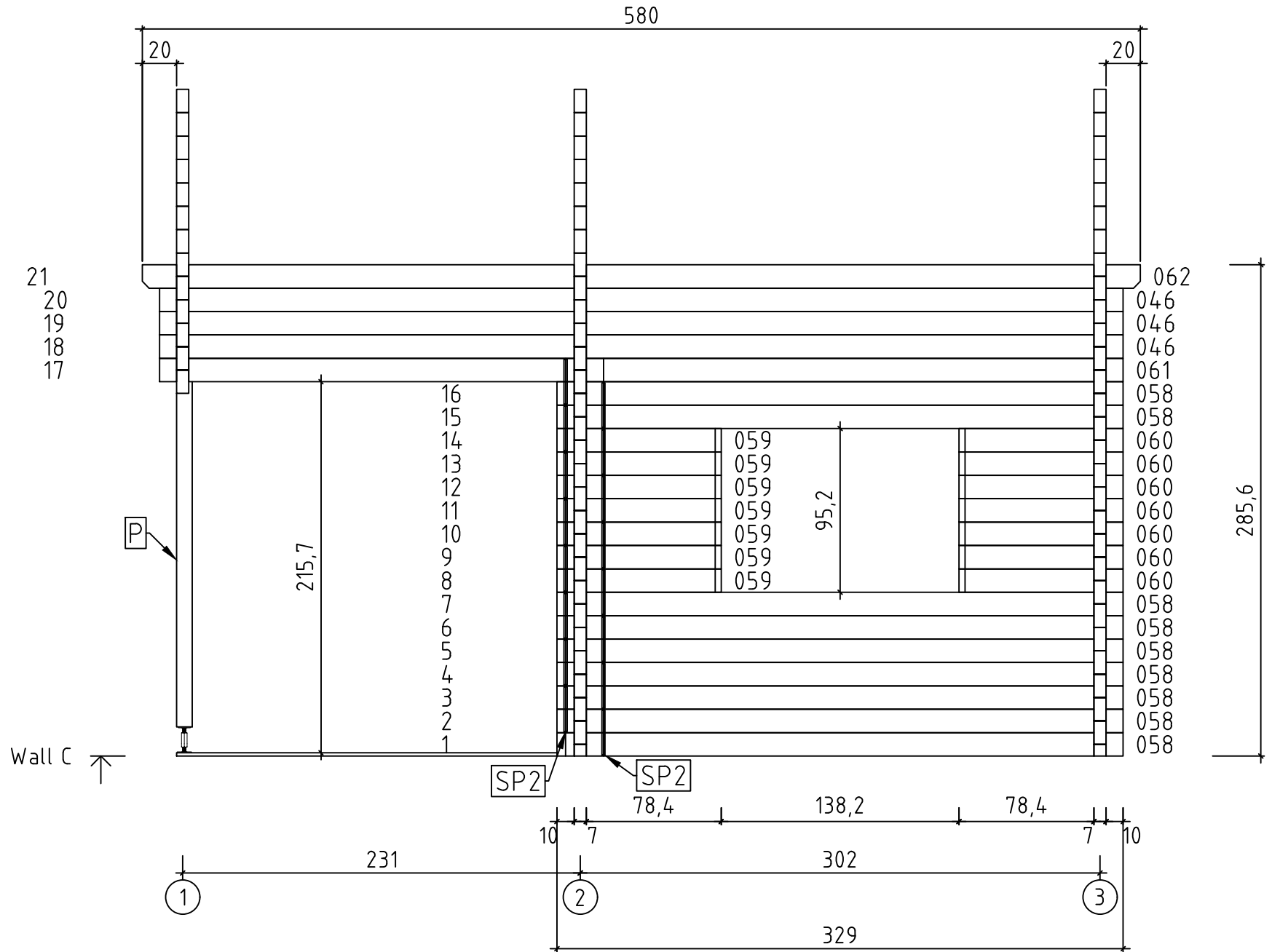



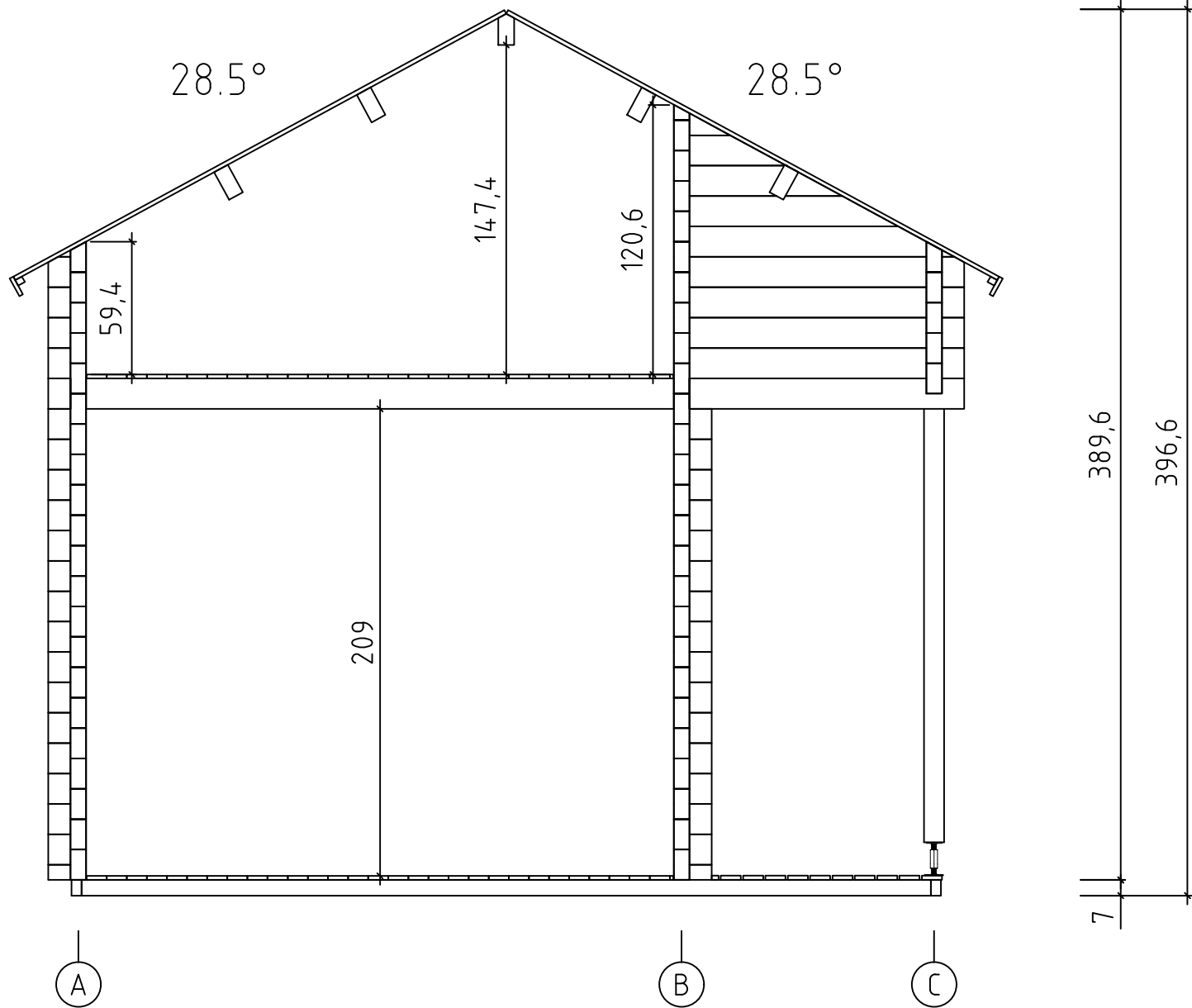

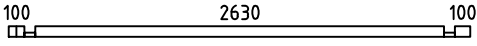
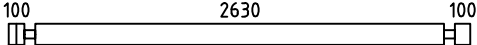
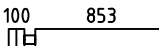
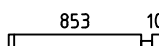
250716.1KL - Bespoke Tahiti 70

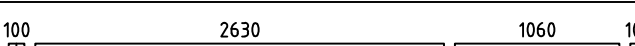
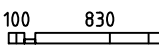
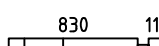

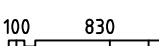
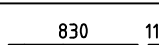

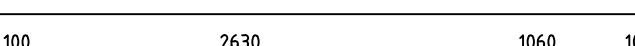
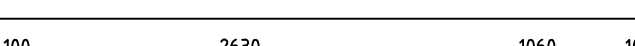
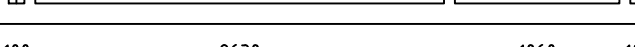
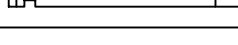
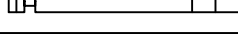
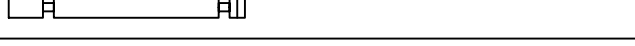
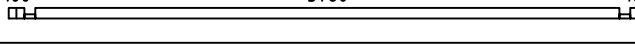
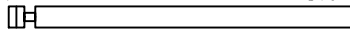

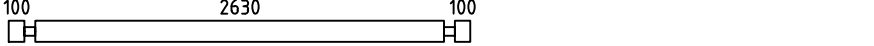
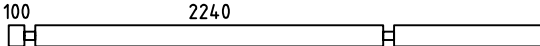
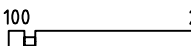





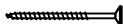
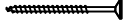





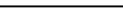

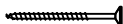
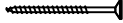

250716.1KL - Bespoke Tahiti 70

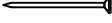

Pos	250716.1KL - Bespoke Tahiti 70 Piece list	Q.	P (mm)	L (mm)
001		1	70x68	2970
002		8	70x136	2970
003		7	70x136	1023
004		7	70x136	1023
005		1	70x136	4100
006		3	70x136	4100
016		1	70x68	1000
017		1	70x68	1012
018		1	70x68	282
019		14	70x136	1000
020		14	70x136	1012
021		14	70x136	282
022		1	70x136	4100
023		1	70x136	4100
024		1	70x136	4100
025		2	70x136	1530
026		2	70x136	1520
034		1	70x68	4100
035		12	70x136	4100
036		7	70x136	2218
037		7	70x136	500
045		3	70x136	2970
046		14	70x136	5600
047		7	70x136	3493
048		7	70x136	1183

Pos	250716.1KL - Bespoke Tahiti 70 Piece list	Q.	P (mm)	L (mm)
049		1	70x136	5600
050		1	70x136	5600
051		1	70x136	5800
052		16	70x136	2580
053		7	70x136	828
054		7	70x136	828
055		1	70x136	2580
056		1	70x136	2580
057		1	70x69	2580
058		9	70x136	3290
059		7	70x136	954
060		7	70x136	954
061		1	70x136	5600
062		1	70x136	5800
W1-1		1		
W2-1		1		
W3-1		1		
IAR1	FOUNDATION 	2	45x70	5390
IAR2	FOUNDATION 	14	45x70	3800

Pos	250716.1KL - Bespoke Tahiti 70 Piece list		Q.	P (mm)	L (mm)
A-PR1		ROOF BEAM	4	70x140	5800
PR1		ROOF BEAM	1	70x140	5800
FB-1	FLOOR BOARDS		42	90x18	2946
FB-2	FLOOR BOARDS		60	90x18	2236
RB	ROOF BOARDS		130	90x18	2500
SV	TERRACE BOARDS		12	90x19	2310
FL	FLOOR FILLET			18x18	33 m.
DPL	ROOFING FELT FILLET		4	18x58	2550
M1	TREADED ROD M12		5		820
M2	TREADED ROD M12		1		1500
M3	TREADED ROD M12		6		2000
DS	DOORSTEP		1	18x74	970
P	POST		1	90x90	2005
TB	EAVES BOARD		4	18x90	2900
DRV	ROOF EDGE REINFORCEMENT		4	28x34	2900
SP1	HIDDEN FIXING		2	18x18	190
SP2	HIDDEN FIXING		51	18x18	260
TBE6-1	FIXING FILLET FOR WINDOW		10	28x34	916
TBE6-2	FIXING FILLET FOR DOOR		2	28x34	1933
	MEZZANINE FLOOR JOISTS		2	45x45	2628
GL	GABLE MOULDING		4	18x120	2550
	MONTAGE SET FOR DOORS AND WINDOWS		1		
KL4	LENGTHENING BOLT FOR TREADED ROD		6		
KL1	DRIVE NUT TREADED ROD		6		
KL2	NUT FOR TREADED ROD		6		

Pos	250716.1KL - Bespoke Tahiti 70 Piece list		Q.	P (mm)	L (mm)
KL3	PLAIN WASHER TREADED ROD		6		
	SCREW FOR GABLE SEGMENT		4	3.5x35	
	SCREW FOR DOORSTEP		4	3.5x50	
HS84	SCREW FOR FIXING FILLET		50	3.5x50	
HS16	SCREW FOR GABLE MOULDING		32	3.5x50	
HS37	SCREW FOR POST		2	4.5x80	
NFD	SCREW FOR ROOFING FELT FILLET		28	4x40	
HS32	SCREW FOR EAVES BOARDS		28	4x40	
HS26	SCREW FOR ROOF EDGE REINFORCEMENT		28	4x40	
HS36	SCREW FOR STEPLADDER		38	4x60	
HS89	SCREW FOR MEZZANINE FLOOR JOISTS		20	5x100	
HS40	SCREW FOR 1. WALL BEAM		11	5x120	
HS78	SCREW FOR STEPLADDER		2	5x120	
	SCREW FOR GABLE		66	5x120	
HS39	SCREW FOR FUNDAMENT		40	5x90	
HS65	SCREW FOR ROOF BEAM		21	6x180	
HS49	SCREW FOR POST HEIGHT ADJUSTMENT		8	6x50	
MS	SCREW FOR DOORSTEP		2	4.5x65	
NF3	SCREW FOR TERRACE BOARD		120	4.2x55	
SH70	HAMMER BLOCK		2		
NFF	ZN NAIL FOR FLOOR FILLETS		66	1.4x40	
NF2	ZN NAIL FOR ROOF		544	2.1x50	
NH1	ZN NAIL FOR FLOOR		563	2.1x50	
GS	GABLE SEGMENT		2		
RFP	POST HEIGHT ADJUSTMENT		1		

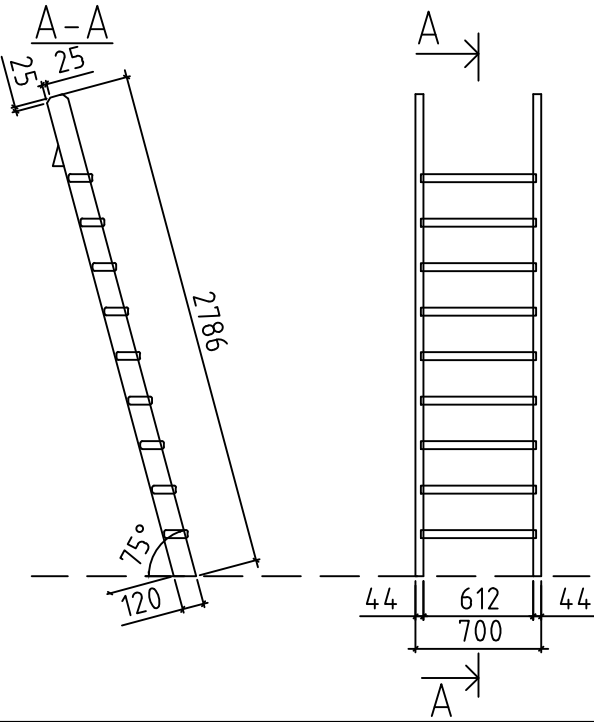
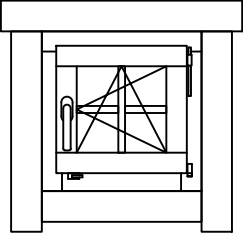
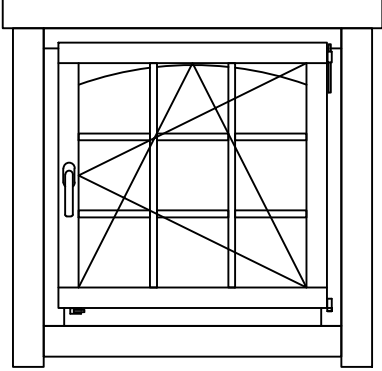
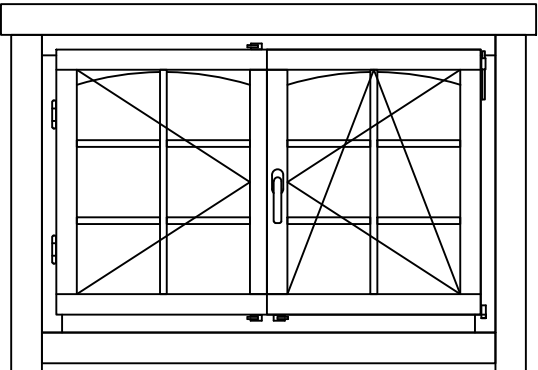
Pos	250716.1KL - Bespoke Tahiti 70 Piece list	Q.	P (mm)	L (mm)
LR	<p>LADDER</p> 	1		
	<p>WINDOW 540x540 2+ A.4P.h</p> 	1		
	<p>WINDOW 916x916 2+ A.9P.A</p> 	3		
	<p>WINDOW 1374x916 2+ TA.6P. A</p> 	2		

